

---

User's Manual

**HT3545 Series**

---

**DC Resistance Meter**



# Content

Introduction.....	1
Checking Packing Contents .....	2
Safety Notes .....	3
Chapter 1 Overview.....	7
1.1 Introduction.....	7
1.2 Characteristics .....	8
1.3 Component Names and Operation Overview.....	9
1.4 Dimension .....	13
1.5 Screen Composition .....	14
Chapter 2 Preparing for Measurement .....	16
2.1 Measurement Process Overview.....	16
2.2 Pre-measurement Inspection.....	19
2.3 Replace the Fuse for Measuring Circuit Protection ....	20
2.4 Confirm the Measured Object .....	20
2.5 Test leads Connection Method.....	21
Chapter 3 Basic Settings.....	23
3.1 Setting Test Range .....	23
3.2 Setting Measurement Speed.....	25
3.3 Temperature Setting.....	26
3.3.1 Temperature Compensation .....	26
3.3.2 Temperature Conversion.....	28
3.4 Average Number of Times Setting .....	32
3.5 Measurement Delay Setting.....	33
3.6 Auto Hold Settings .....	36
3.7 Abnormal Mode Setting.....	37
3.8 OVC (thermoelectric compensation) Function Setting	

.....	39
3.9 Display Digit Setting .....	41
3.10 Test Current Setting.....	42
3.11 Contact Detection Settings .....	44
Chapter 4 Comparator Settings .....	45
4.1 Comparator Function .....	45
4.1.1 Comparison Result Signal Output Method.....	46
4.2 Comparison Mode .....	47
4.2.1 Absolute Value Mode.....	47
4.2.2 Percentage Mode.....	49
4.3 Multi-bins Sorting Function .....	51
4.3.1 Sorting Function Turn on Settings .....	51
4.3.2 Sorting Function Range Setting.....	52
4.3.3 Sorting Function Upper and Lower Limit Settings .....	53
4.3.4 Sorting Function Standard Difference Value Setting.....	53
Chapter 5 Measurement.....	54
5.1 Start Test .....	54
5.2 Measuring Value Display.....	55
5.3 Automatic Protection Function .....	56
5.4 Perform Clear Zero.....	57
Chapter 6 Measurement Panel Save .....	61
6.1 Save Panel Setting.....	61
6.2 Retrieve Measurement Settings .....	62
6.3 Delete Measurement Settings .....	62
6.4 Rename Measurement Settings .....	62
Chapter 7 System Settings.....	63

7.1 Button Sound Setting.....	63
7.2 Self-calibration Function .....	63
7.3 Power Frequency Setting .....	65
7.4 Radio Mode Setting.....	66
7.5 Communication Mode.....	66
7.5.1 RS232 Communication Mode.....	66
7.5.2 LAN Protocol.....	68
7.6 USB Interface.....	70
Chapter 8 Externally controlled EXT I/O.....	71
8.1 Trigger Source Settings.....	71
8.2 Trigger Level Setting.....	72
8.3 Level Mode Setting.....	73
NPN Wiring Method .....	74
PNP Wiring Method .....	74
8.4 EOC Mode Setting .....	75
8.5 Output Mode Setting.....	76
8.6 Port Signal Details.....	78
8.6.1 Port and Signal Description .....	79
8.6.2 Port Diagram.....	79
8.6.3 Port Signal Connection Method .....	81
8.6.4 Input Circuit Connection.....	82
8.6.5 Output circuit connection.....	83
8.7 Timing Diagram.....	83
8.8 Timing Diagram External Control Confirmation .....	87
Chapter 9 Parameter .....	89
9.1 General Parameters .....	89
9.2 Accuracy.....	1



## Introduction

Thank you for purchasing 3545 precision resistance meter. To obtain maximum performance from this product, please read this manual first before operation, and keep it handy for future reference.

Registered trademarks

Windows and Excel are registered trademarks of Microsoft Corporation in the United States and/or other countries.

## Checking Packing Contents

When receiving instrument, please check carefully to ensure that the instrument is not damaged during transit. In addition, special inspections of accessories, panel switches and connectors are required. If the instrument is found to be damaged or it fails to operate as described in the user manual, please contact us.

To transport this instrument, use the original packaging and wrap it in a double carton. Damage during transit is not covered by the warranty.

### Packing List

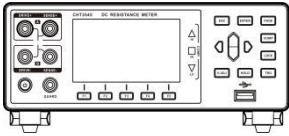

HT3545\*1unit

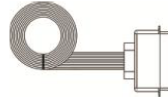

CHT9600 handler cable\*1pc (optional)



CHT9344 test leads\*1pc

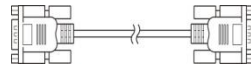

CHT9800 communication cable\*1pc



CHT9366 temperature probe\*1pc



AC power cord\*1pc

User manual\*1 copy



## Safety Notes

The instrument is designed to comply with the IEC 61010 safety standard and has been thoroughly tested for safety prior to shipment. However, if it is used improperly, it may cause injury or death and damage the instrument. Be sure to read through this manual and its precautions before use. Our company does not assume any responsibility for accidents and injuries caused by defects in the instrument itself. This manual marks the relevant signs for safe operation of the instrument. In order to ensure the safety of the instrument and its users, please read the following safety signs and operating precautions carefully before use.

## Safety Signs



The sign in this manual is particularly important and should be read carefully before using the machine.



Stands for DC (Direct Current).



Stands for fuse



Stands for earth terminal

### Installation Environment





- Operating temperature and humidity:  
0 to 40 ° C, below 80% RH (no condensation)
- Temperature and humidity range that can ensure accuracy:  
-10-50°C, below 80% RH (no condensation)
- To avoid malfunction or damage to the instrument, do not place the tester in the following situations:
  - Places where the sun is shining directly at high temperatures
  - It will splash to the place where the liquid temperature is high and condensation occurs.
  - Exposed to dusty places
  - Locations where corrosive or explosive gases are flooded
  - Locations with strong electromagnetic fields and electromagnetic radiation
  - Places where mechanical vibration is frequent

## Checking before use



Before using this instrument, verify that the operation is normal and that there is no damage during storage or transportation. If you find any damage, please contact us.

 WARNING	Before using the instrument, make sure that the AC power cord and test leads are well insulated and whether there are conductors are exposed. If a similar situation occurs, there is a danger of electric shock when using this instrument. Please contact us.
-------------------------------------------------------------------------------------------	-----------------------------------------------------------------------------------------------------------------------------------------------------------------------------------------------------------------------------------------------------------------

## Handling Precautions

 DANGER	Do not wet the instrument or use wet hands for operating it. Do not modify or disassemble it yourself. Otherwise, it may cause fire, electric shock or other accidents.
 CAUTION	There are high pressure and high temperature parts inside the instrument during operation, in order to avoid electric shock, do not disassemble instrument electronic enclosure.
 CAUTION	To avoid damage to the instrument, physical shock should be prevented when handling and operating the instrument. Special care should be taken to prevent the instrument from falling.
 NOTE	Be sure to turn the power off after using it.

## Handling leads and cables

 DANGER	To prevent an electric shock, do not short-circuit the top of the test leads and the lines with voltage.
 CAUTION	<ul style="list-style-type: none"><li>• When testing, for your safety, please use the instrument's own test leads option.</li><li>• To avoid damaging test leads, do not bend or stretch the test leads.</li><li>• To avoid damage to the test leads, do not take the cables while you are plugging or unplugging the test leads. Hold the connectors.</li><li>• The probe at the front of the test leads is sharp, taking care not to be scratched.</li></ul>

## Accuracy

We use the f.s. (full range), rdg. (reading) and dgt. (resolution) values to define the measurement tolerances, which have the following meanings:

f.s. (Maximum display value or measurement range)

This is usually the maximum display value. In the instrument, this indicates the currently used range.

rdg. (Reading or displayed value)

The value currently being measured and the value indicated on the measuring instrument.

dgt. (Resolution)

The smallest displayable unit on a digital measuring instrument, i.e., the input value that causes the digital display to show a "1" .

## 1.1 Introduction

The basic accuracy of HT3545 DC resistance tester is 0.01%, and the measurable range is  $0.01\mu\Omega \sim 1200M\Omega$ . With high-speed test line anomaly detection and extremely short measurement cycle, the highest sorting speed is up to 2.2mS per meas, ensuring high-speed and reliable sorting every time. HT3545 can be freely configured for multi-stage sorting, and external control interface can be configured as NPN/PNP. It is suitable for various signal interfaces of Automatic production line

HT3545 uses four-terminal test method to measure DC resistance of various materials such as winding resistance of motors and transformers, contact resistance of relays and switches, pattern resistance of printed circuit boards, fuses, resistors and conductive rubber at high speed and high precision. Since the instrument is equipped with a temperature compensation function, it is most suitable for measuring the object whose resistance value changes due to temperature. In addition, it is equipped with comparator functions, communication, external control, etc., and can be used in various situations such as development and production lines. HT3545A cooperates with multi-channel scanning tester to test PCB vias and traces in aerospace, automotive electronics and other fields, and can scan and switch at a speed of 1ms.

## 1.2 Characteristics

### Exterior

- 3.5-inch high-resolution TFT LCD display, easy to operate
- Compact and powerful

### High technical specifications

- $10\text{m}\Omega \sim 1200\text{M}\Omega$ , 6.5 digits display, basic accuracy 0.01%
- The highest resolution is  $0.01\mu\Omega$

### Quick Measurement

- Minimum test cycle only needs 2.2ms

### Rich interface

- External control I/O port
- RS-232 interface
- Ethernet interface
- Temperature test interface

### powered by

- 100~240V power supply
- Power frequency 50/60Hz

# 1.3 Component Names and Operation Overview

## Front Panel

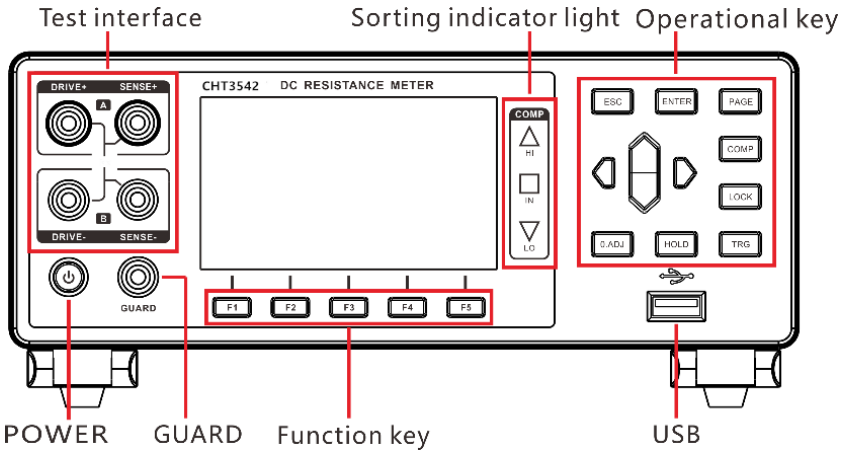

## Rear Panel

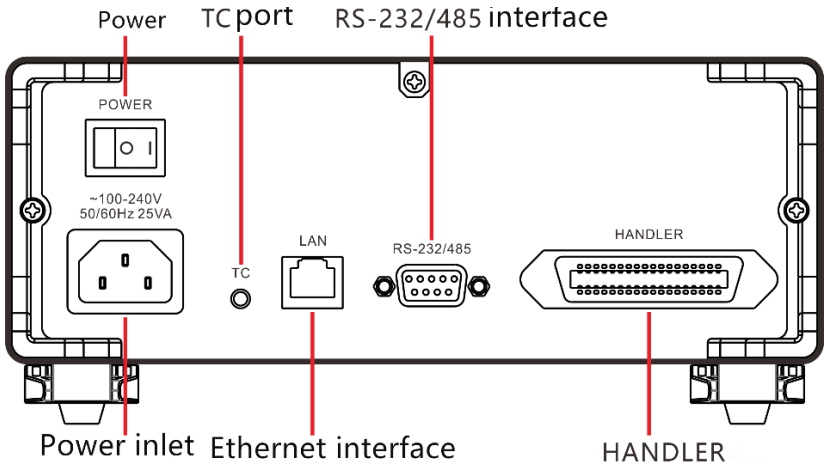

## Side View

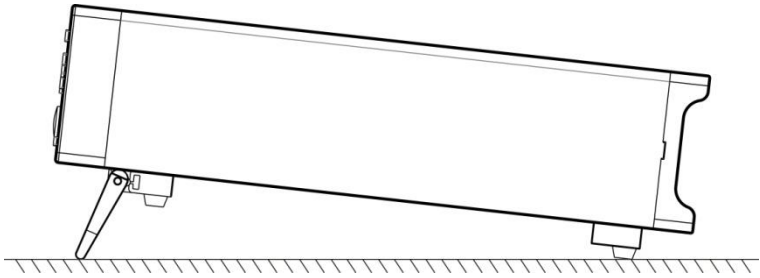



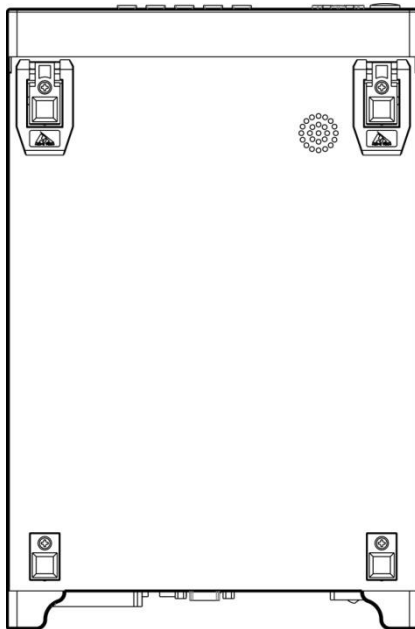









## Bottom





## Keys

Keys	Description
	Function key F1
	Function key F2
	Function key F3
	Function key F4
	Function key F5
	Function key Escape
	Function key Enter
	[Page Switch] Switches [Measurement Page] <-> [Comparator Page] <-> [Setup Page] <-> [Panel Page] <-> [System Page] <-> [I/O Page]
	Comparator on/off button
	<b>Lock key</b> Short press [LOCK] key to lock the current page and the other keys get invalid. Long press to unlock.

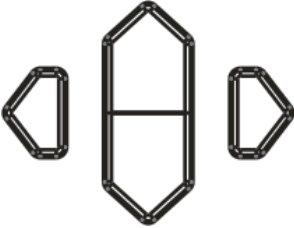
	<p>[0.ADJ] key  Short press for clear zero function.  Long press to release clear zero function</p>
	<p>[HOLD] key  Hold the current measurement during the test</p>
	<p>[Trigger] key  Single trigger test to the instrument in manual trigger mode</p>
	<p>[Direction] key,  Select menu items or set values</p>

## 1.4 Dimension

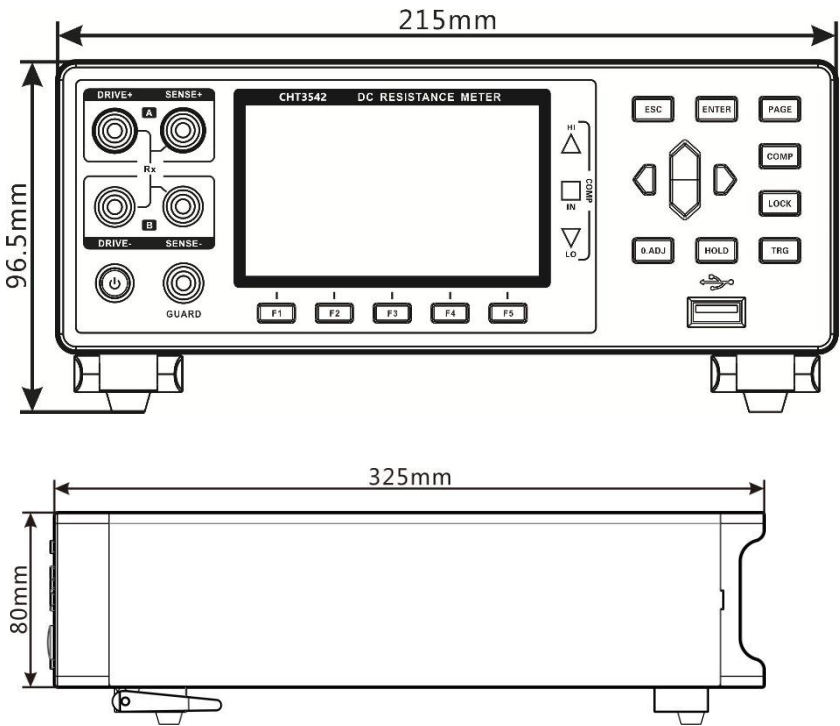

## 1.5 Screen Composition

### Measurement Display

					
MEAS	COMP	SET	PANEL	SYS	I/O
Range <b>20mΩ</b> Auto Range <b>OFF</b> RATE <b>FAST</b>					
					25.0°C
<b>1.0000mΩ</b>					
Range↑	Range↓	AUTO	Speed	TEMP	

### Comparator Display

					
MEAS	COMP	SET	PANEL	SYS	I/O
BEEP	<input type="text" value="OFF"/>				
MODE	<input type="text" value="ABS"/>				
RANG	<input type="text" value="20mΩ"/>				
MULTI	<input type="text" value="OFF"/>				
UPPER	<input type="text" value="10.0000mΩ"/>				
LOWER	<input type="text" value="10.0000mΩ"/>				
OFF	PASS	FAIL	BEEP A	BEEP B	

### Measuring Parameter Setting Display

					
MEAS	COMP	SET	PANEL	SYS	I/O
TC SET	<input type="text" value="OFF"/>	DeltaT	<input type="text" value="OFF"/>		
AVERAGE	<input type="text" value="OFF"/>	DELAY	<input type="text" value="PRESET"/>		
AUTO HOLD	<input type="text" value="OFF"/>	ERR MODE	<input type="text" value="CurrERR"/>		
OVC	<input type="text" value="OFF"/>	MEAS CURR	<input type="text" value="HIGH"/>		
DIGIT	<input type="text" value="6"/>	CONTACT IMPARV	<input type="text" value="OFF"/>		
OFF	ON	SET			

## Parameter Saving Display

	MEAS	COMP	SET	PANEL	SYS	I/O
No.	Name					
01	-----					
02	-----					
03	-----					
04	-----					
05	-----					
06	-----					
07	-----					
08	-----					
09	-----					
SAVE						

## System Parameter Setting Display

	MEAS	COMP	SET	PANEL	SYS	I/O
KEY BEEP	OFF					
CALIB	ABS					
POW FREQ	50HZ					
RADIO	OFF					
COM MODE	RS232					
BAUD RATE	9600					
LANGUAGE	ENGLISH					
中文	ENGLISH					

## I/O Setting Display

	MEAS	COMP	SET	PANEL	SYS	I/O
TRG SOURCE	INT					
TRG EDGE	ON-OFF					
OUT MODE	NPN					
EOC MODE	HOLD					
JUDGE MODE	JUDGE					
I/O TEST	EXEC					
INT	EXT					

## Chapter 2 Preparing for Measurement

### 2.1 Measurement Process Overview

The instrument is kept power off, the following steps are taken to prepare for testing.

1. Turn off the instrument and connect the test leads.

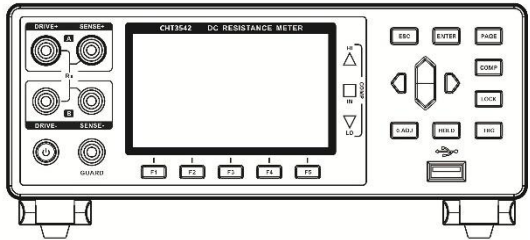
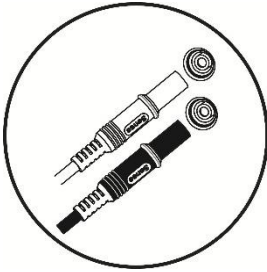

2. Plug AC power cord into the mains outlet

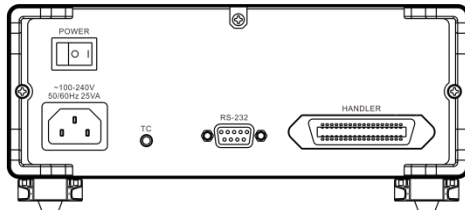
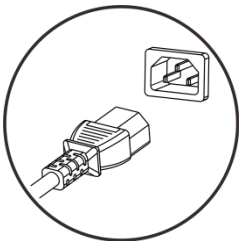

Ensure that the power cord is well grounded, which is conducive to the stability of the test.

3. Turn on the power at back of instrument.

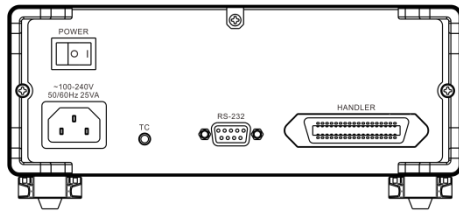
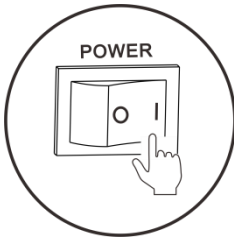

At the time being, internal power of the instrument has been turned on and the instrument is in standby mode.

4. Press and hold POWER button on panel to turn on the power.

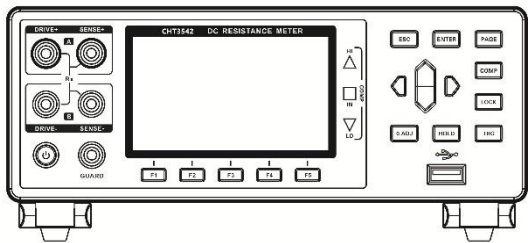
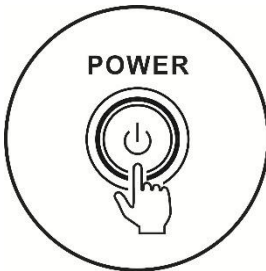

When instrument is in the standby mode, POWER button at panel light is red, long press POWER button, the power is turned on, the screen is lit, and light of button at panel turns green.

## 5. Setting test parameters

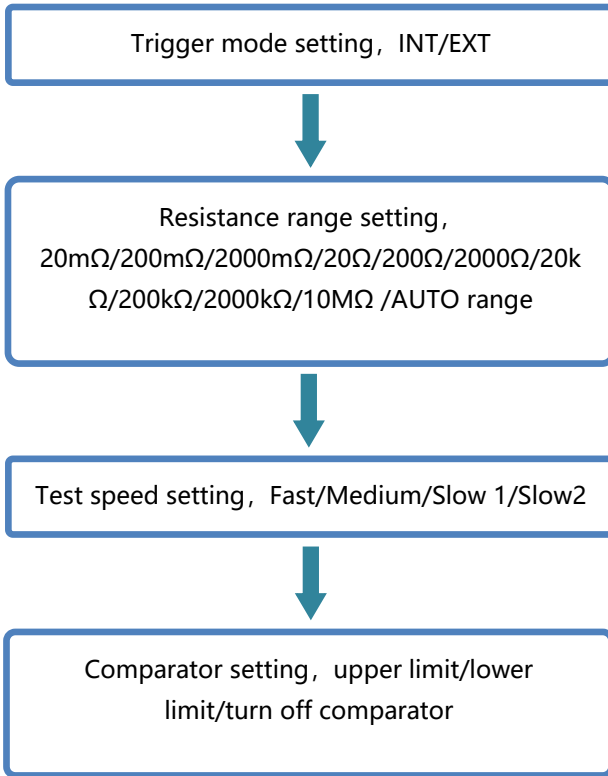

## 6. Start to test

7.

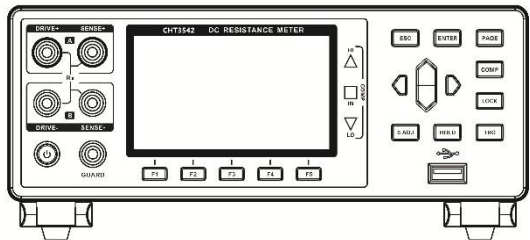
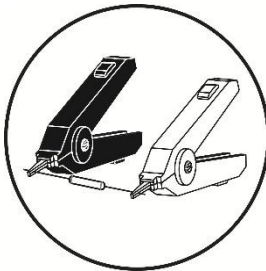



## 7. Complete test, turn off the power

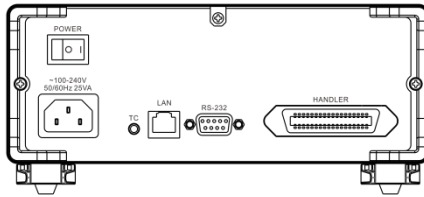
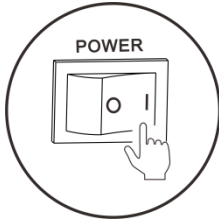

## 2.2 Pre-measurement Inspection

Before using the instrument, inspect it to verify that no damage has occurred during storage or transportation and it operates normally. If you find any damage, contact us.

### Instrument and peripheral checking

Inspection item	Action
Is there any damage or a crack in the instrument? Are the internal circuits exposed?	If any damage is found, do not use it. Return it for repair.
Is there any dust or contamination, such as pieces of metal, on any terminals?	If dust or contamination is adhered to a terminal, clean the terminal with a swab.
Is the test lead coating broken or is the metal exposed?	If the coating of a test lead is broken, the measured value may become unstable or have an error. It is recommended to replace the intact wire.

### Power-on checking

Inspection item	Action
After turn on the power on at the back of the instrument, check whether instrument <b>POWER</b> button lit or not?	Return the instrument for repair, if the <b>POWER</b> button is not lit.

When power is turned on, does the entire display turn on? the model name and measurement screen are displayed normally?	If the screen does not behave like this, the instrument may be damaged internally. Return it for repair.
-------------------------------------------------------------------------------------------------------------------------	----------------------------------------------------------------------------------------------------------

### 2.3 Replace the Fuse for Measuring Circuit Protection

When the measuring circuit protection fuse is blown, please replace it as described in below.

note:

- To avoid electric shock, turn off the power and replace the fuse after removing the test leads.
- Use fuses with specified shapes, characteristics, current ratings and voltages. Do not use a fuse other than the specified one (especially a fuse with a large rated current), or continue to use the fuse box in a short-circuited state. Failure to do so may result in damage to the instrument and personal injury.
- Specified fuse: T2A/250V

### 2.4 Confirm the Measured Object

Please change the measurement conditions appropriately according to the object to be measured to reliably measure the resistance. Please refer to the recommended examples shown in the table below to start measurement after setting up instrument.

Measured object	Recommended setting			
	Test current	TC/ $\Delta$ T	OVC	Contact detection

Motor, solenoid, choke, transformer	High	TC	OFF	ON
Signal contact harness, connector, relay contact, switch	-	TC	-	OFF *3
Power contact harness, connector, relay contact, switch	High	TC	ON	ON
Fuse, resistor	Low *1	-	ON	ON
Conductive coating, conductive rubber	High	-	OFF	OFF
Other, common resistance measurement heaters, wires, welded parts	High	*2	ON	ON
Temperature rise test motor, choke, transformer	High	$\Delta T$	OFF	ON

\*1 When the rated power has a margin, select High

\*2 When the temperature dependence of the measured object is large, use temperature compensation

\*3 When the allowable voltage is allowed to have a margin, select ON.

## 2.5 Test leads Connection Method

### WARNING

- The test leads port is sharp, taking care not to be scratched.
- For safety reasons, test leads supplied with the instrument should be used.
- To avoid electric shock, make sure the test leads are properly connected

## Front panel connection

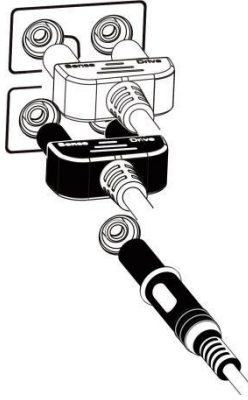

## Test leads connection

1. 9344 Test clip type test leads

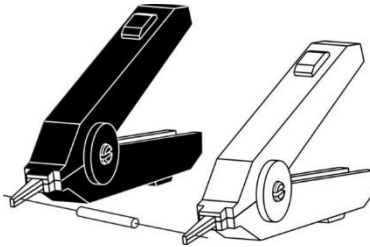

2. 9363-B Test probe type test leads

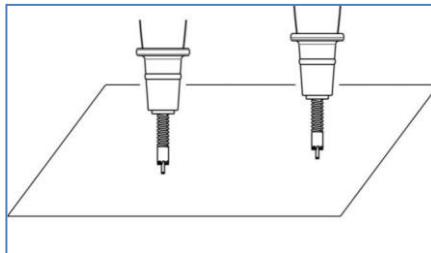

### 3.1 Setting Test Range

The range setting is divided into manual range and auto range. When auto range is selected, the instrument automatically selects an appropriate range to test based on the value of the measured resistance.

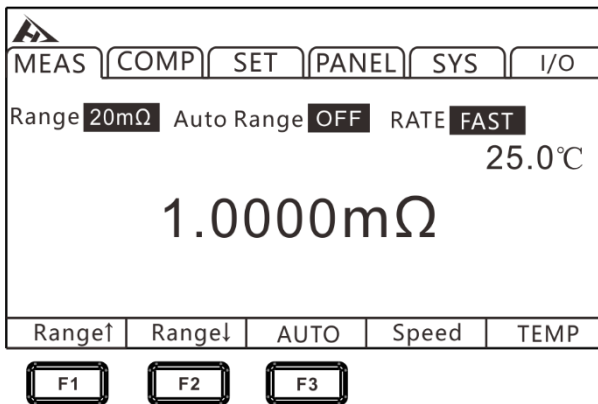

#### 3.1.1 Manual Range Setting

Under measurement state, press [F1] or [F2] to switch the range. Even if auto range function is turned on, manual range switching is also valid (when the auto range is turned on, auto range function will be automatically turned off when the range is manually switched).

##### Range:

20mΩ ↔ 200mΩ ↔ 2000mΩ ↔ 20Ω ↔ 200Ω ↔ 2000Ω ↔  
20kΩ ↔ 200kΩ ↔ 2000kΩ ↔ 10MΩ

## 3.1.2 Auto-Range Setting

Under measurement state, press [F3] to switch to auto range.

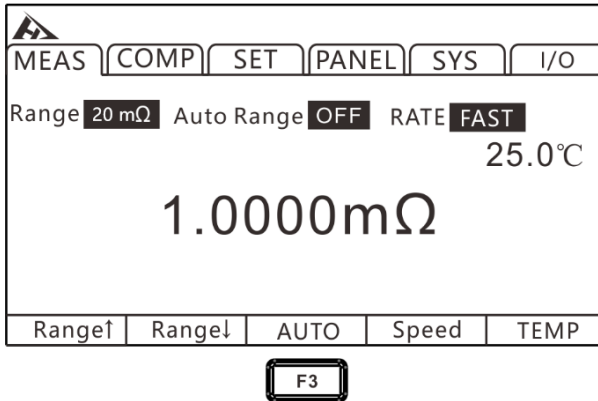

### Note:

- If the range is changed while the auto range is ON, the auto range is automatically canceled and is changed to manual range .
- If the comparator function is set to ON, the range is fixed and cannot be changed (it cannot be switched to auto range). To change the range, set the comparator function to OFF or change the range in the comparator settings.
- The auto range may become unstable due to the measured object. In this case, manually specify the range or extend the delay time.

## 3.2 Setting Measurement Speed

The measurement speed is divided into four levels: fast, medium, slow 1, and slow 2. Press [F4] to switch. The test accuracy of medium speed, slow speed 1 and slow speed 2 is higher than fast speed and is not easily affected by the external environment. When it is susceptible to the external environment, please fully shield the test object from the test leads and wrap the cable.

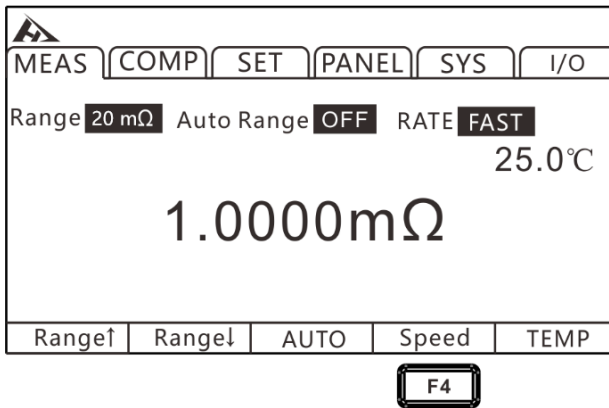

### Note:

- When the measurement delay is set, the sampling period becomes slower.
- Test time includes ADC sampling, sorting output, and display time.
- In the test environment, when the electric field interference is relatively large, or when the test is difficult to stabilize, a slow test is recommended.
- Perform a self-calibration of approximately 5ms between measurements. To shorten the measurement interval, set the self-calibration to manual.

## 3.3 Temperature Setting

Press [F5] on measurement page to switch whether the current temperature is displayed.

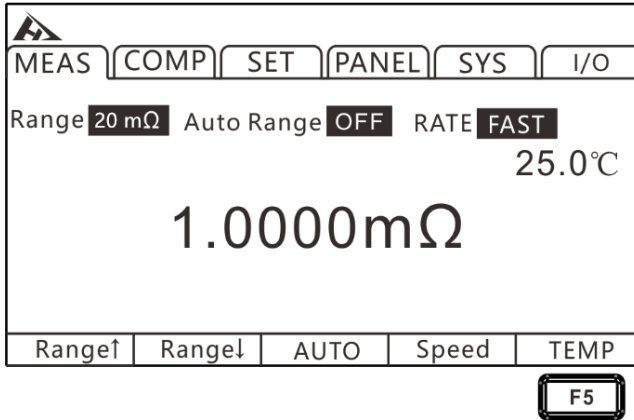

If temperature probe is not connected, temperature measurement is not possible. When the TC or  $\Delta T$  is not used, there is no need to connect a temperature probe. If users do not want to display the temperature, please switch the display.

### 3.3.1 Temperature Compensation

Resistance value is converted to reference temperature for display. When need compensating for temperature, please connect the temperature probe to the TC terminal on the rear panel of the instrument.

1. Select parameter setting page



Press [PAGE] Button to parameter setting page



## 2. Select related menu items

Press [F2] to turn on temperature compensation. After the temperature compensation is set to ON, users need to press [F3] to set the reference temperature and temperature coefficient.

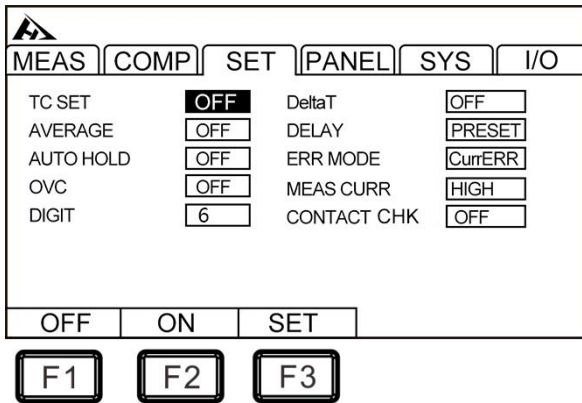

## 3. Related values setting

Press [F3] to enter reference temperature and temperature coefficient setting page, press [F1] to enter setting, use left and right cursor keys to move the cursor to the position to be set, and use the up and down cursor keys to change value.

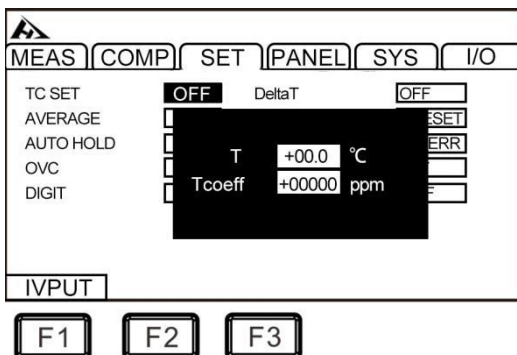

The principle of temperature compensation is as follows:

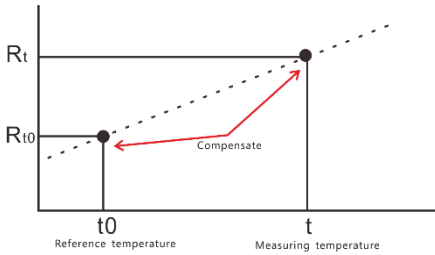

$$R_{t0} = \frac{R_t}{1 + \alpha_{t0}(t - t_0)}$$

$R_t$  : Actual resistance value

$R_{t0}$  : compensation resistance value

$t$ : Measuring temperature

$t_0$ : Reference temperature (setting range from  $-10^{\circ}\text{C}$ ~ $99.9^{\circ}\text{C}$ )

$\alpha_{t0}$ : Temperature coefficient at  $t_0$  of the material being tested  
(setting range from  $-9999\text{ppm}/^{\circ}\text{C}$ ~ $9999\text{ppm}/^{\circ}\text{C}$ )

Note:

When "t.error" is displayed, it indicates that the temperature probe is not connected; if temperature is displayed as ---., please confirm connection of the temperature probe.

### 3.3.2 Temperature Conversion

When performing temperature conversion, connect temperature probe to TC terminal on rear panel of the instrument. The temperature rise value can be converted according to the principle of temperature conversion, and the temperature at time of energization stop can be estimated.

### 1. Select parameter setting page



Press **[PAGE]** Button to parameter setting page

### 2. Select related menu items

Press **[F2]** to turn on temperature conversion. After temperature conversion is set to ON, users need to press **[F3]** to set relevant value.

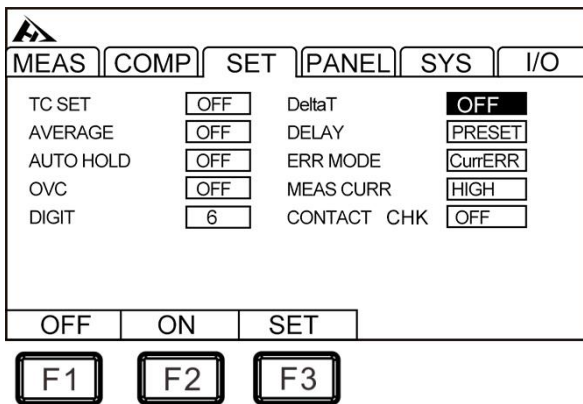

### 3. Related values setting

Press [F3] to enter setting page of initial resistance value, initial temperature, and inverse of the temperature coefficient (K) at 0 °C.

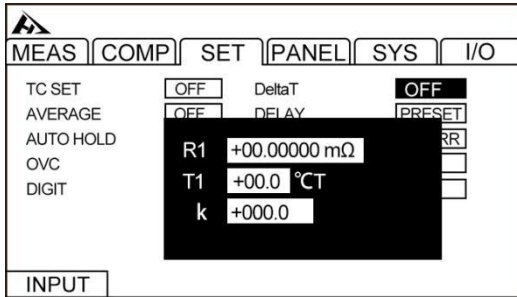

Press [F1] input key to start setting, use left and right cursor keys to move cursor to the position to be set, and use up and down cursor keys to change the value.

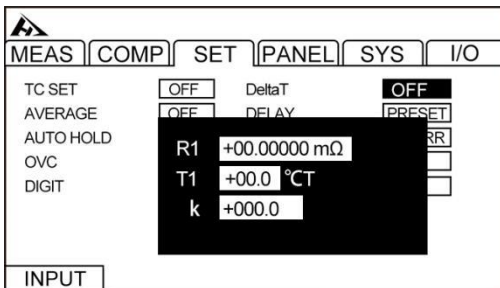

Press the up, down, left and right keys to select the value to be set

### Setting range:

Initial resistance: 0.001Ω ~ 9000.000 MΩ

Initial temperature: -10.0 ~ 99.9 °C

### Reference value of k:

The following values are recommended in the JIS C4034-1 standard.

- Copper:  $k = 235$
- Aluminum:  $k = 225$

Temperature conversion test example:

- 1 Make motor and coil fully adapt to room temperature, then measure resistance value ( $R_1$ ) and ambient temperature ( $t_1$ ) before power-on and input value into the instrument.
- 2 Remove the test leads from the object under test.
- 3 After power is turned OFF, connect test leads to the object to be measured again, and measure the temperature rise value ( $\Delta t_1 \sim \Delta t_n$ ) at regular intervals.
- 4 Connect collected temperature data ( $\Delta t_1$  to  $\Delta t_n$ ) and estimate maximum temperature rise value ( $\Delta t$ ).

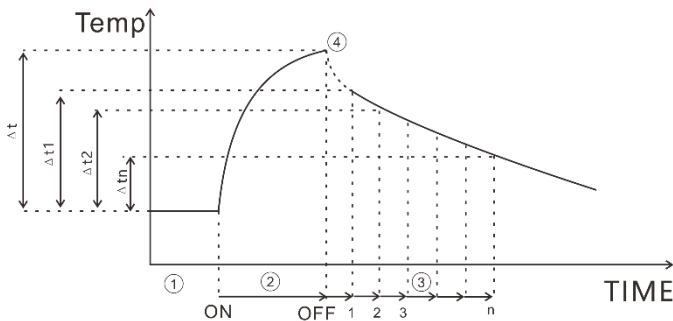

Note:

- When  $\Delta T$  is ON, comparator cannot be set to ON.
- If TC and multi-sorting functions are set to ON,  $\Delta T$  will automatically turn into OFF status.

## 3.4 Average Number of Times Setting

A plurality of measured values are averaged and displayed. By using this function, the jitter of measured value can be reduced and interference can be suppressed.

When internally triggered, (free measurement) is calculated by moving average.

When externally triggered, (non-free measurement) is a simple average.

**Average number of times:**

OFF ↔ 2 ↔ 3 ↔ 4 ↔ 5 ↔ 6 ↔ 7 ↔ 8 ↔ 9 ↔ 10

Average method	1 <sup>st</sup>	2 <sup>nd</sup>	3 <sup>rd</sup>
Free measurement (moving average)	$(D1+D2)/2$	$(D2+D3)/2$	$(D3+D4)/2$
Non-free measurement (simple average)	$(D1+D2)/2$	$(D3+D4)/2$	$(D5+D6)/2$

The average value when average number of times is set to 2:

When low current resistance measurement is ON, and test speed is slow 2, even if the average function is set to OFF, the internal average processing is performed twice. When average function is set to ON, averaging process is performed by the set number of times.

### 1. Select parameter setting page



Press [PAGE] Button to parameter setting page

### 2. Select related menu items

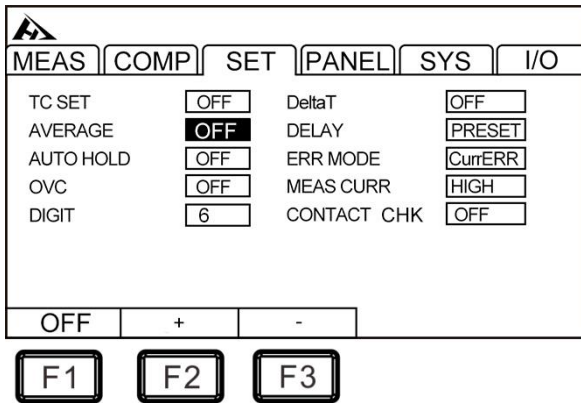

Press [F2], average number of times increases, press [F3] to decrease the average number of times, maximum average number of times is 10 times, and minimum is 2 times.

### 3.5 Measurement Delay Setting

Set waiting time after the OVC (Thermal Compensation Function) is turned on and measurement current is changed under the auto range to adjust the measurement stabilization time. By using this feature, even if reactance component of the object to be measured is large, the measurement can be started after internal circuit is stabilized. Preset settings vary depending on the range or offset voltage compensation function.

The delay setting can be selected from the preset (internal fixed value) and any 2 types of set value.

(1) The preset (internal fixed value) value will vary according to the range or OVC function.

Range	Test current	Delay (unit: ms)	
		OVC: OFF	OVC: ON
20 mΩ	-	75	25
200 mΩ	High	250	25
	Low	20	2
2000 mΩ	High	50	2
	Low	5	2
20 Ω	High	20	2
	Low	5	2
200 Ω	High	170	2
	Low	20	2
2000 Ω	-	170	2
20 kΩ	-	180	-
200 kΩ	-	95	-
2000 kΩ	-	10	-
10 MΩ	-	1	-

## (2) Arbitrarily set value

Setting range is 0 to 9999 ms, which is the value set for all ranges.

### 1. Select parameter setting page



Press **PAGE** Button to parameter setting page

### 2. Select related menu items



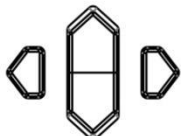
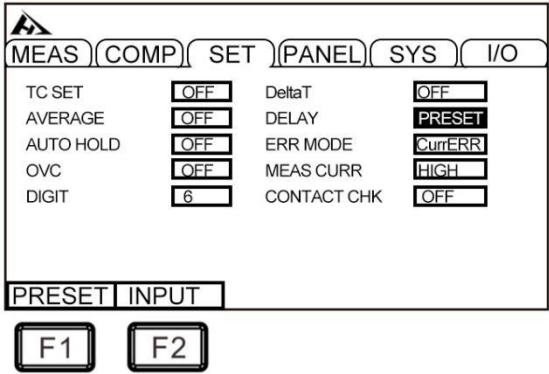

Press the up, down, left and right keys to select the value to be set

3. Press [F2] to enter delay time

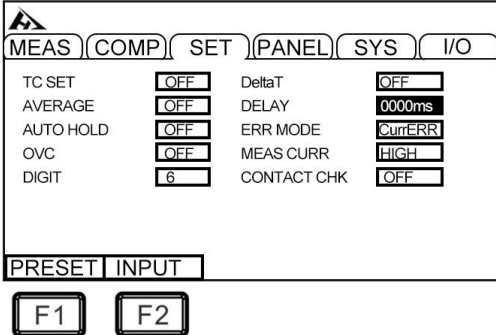

Press the up, down, left and right keys to select the value to be set

**Approximate calculation criteria for inductive load delay time**

- When applying a measurement current to an inductive load, it takes a certain amount of time to stabilize. When it is not possible to make measurements in initial state (preset), adjust the delay. Set the delay time to approximately 10 times the following calculated value to ensure that the reactance components (inductors, capacitors) do not affect the measured value.

$$t = -\frac{L}{R} \ln\left(1 - \frac{IR}{V_o}\right)$$

L : inductance of the measured object

R : resistance of the object to be measured + wire resistance + contact resistance

I : Measuring current

- Initially set the delay time to a longer time and then gradually reduce the delay time while observing the measured value.
- If the delay time is extended, the display update of the measured value will become slower.

### 3.6 Auto Hold Settings

It is very convenient to use hold function when confirming the measured value. When measured value is stable, buzzer will sound and be automatically held.

1. Select parameter setting page



Press **[PAGE]** Button  
to parameter setting page

2. Select related menu items

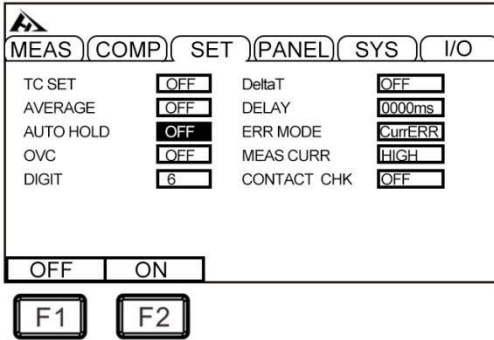

Press the up, down, left and right keys to select the value to be set

About automatic hold release:

When test leads are removed from the object to be measured and brought into contact with the object to be measured again, the hold is automatically released. Changing range and measuring speed or pressing [ESC] can also cancel the hold. If the hold is released, HOLD indicator will go out.

## 3.7 Abnormal Mode Setting

The abnormal mode can be set to [current abnormality] and [overrange]

1. Select parameter setting page



Press **[PAGE]** Button to parameter setting page

2. Select related menu items

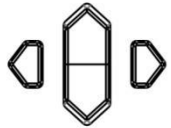
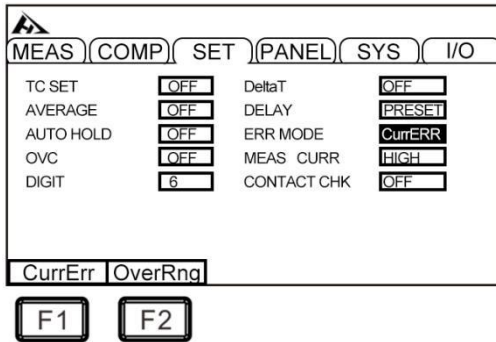

Press the up, down, left and right keys to select the value to be set

### Overrange detection example

Overflow Detection	Measurement Example
When overrange	20 kΩ measurement on a 23 kΩ range
Deviation of the measured value is displayed (% display) when the display range (999.999%) is exceeded	500 Ω (+2400%) measured at a standard value of 20 Ω
When the result of clear zero operation is out of the display range	0.5 Ω zero adjustment in 1 Ω range → 0.1 Ω measurement → operation result -0.4 Ω, out of display range
When the input of the A/D converter is out of range during measurement	High-resistance measurement, etc. in environments with high external noise
When the current does not flow to the measured object normally (only when the current abnormal mode is set to overrange output)	If the current is abnormally displayed as "-----" when the SOURCE A terminal or SOURCE B terminal is defective when the target is defective, set the current abnormal mode to current abnormality.

Examples of current anomalies:

- Place SOURCE A, SOURCE B probes in an open status
- The measured object is disconnected, etc. (Open circuit components)
- SOURCE A, SOURCE B wiring disconnection, poor connection

**Note:**

- If SOURCE wiring resistance exceeds the following value, a current abnormality will occur and measurement will not be possible. Under measurement current range of 1 A, control the contact resistance between the wiring resistance and the object to be tested and test leads to a low level.

### 3.8 OVC (thermoelectric compensation) Function Setting

Automatically compensates for the thermoelectric potential or the internal bias voltage of the instrument. (OVC: Offset Voltage Compensation)

1. Select parameter setting page



Press **[PAGE]** Button  
to parameter setting page

2. Select related menu items

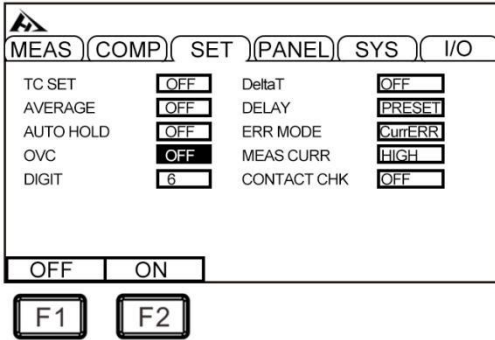

Press the up, down, left and right keys to select the value to be set

When OVC function is turned on, the measured value RP when the measured current flows and the measured value RZ when the measured current does not flow are displayed in the upper right corner of the page OVC, RP-RZ is displayed as the true resistance value.

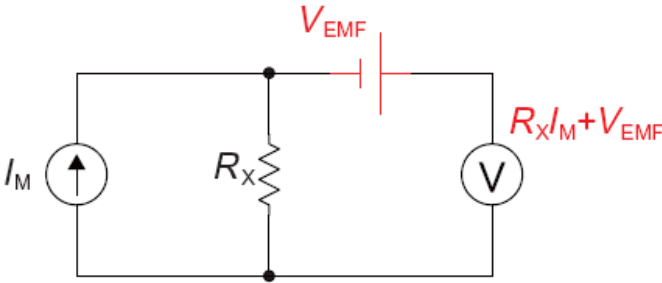

**$V_{EMF}$ :** The thermoelectric potential, when any metal is in contact, generates an electric potential. The magnitude of electric potential is related to temperature.

**$R_x$ :** measured resistance

When injection test current is  $I_M$ ,  $V_1 = V_{EMF} + R_x I_M$

When  $I_M = 0$ ,  $V_2 = V_{EMF}$ ,  $V = V_1 - V_2 = R_x I_M$

The effect of thermoelectric potential can be offset by a simple subtraction operation.

Note:

- When bias voltage compensation function is ON (OVC indicator is lit), the display of measured value will be updated slowly.
- When low current resistance measurement is OFF, the bias voltage compensation function can be set to ON, 10 k $\Omega$  range in the range of 10 m $\Omega$  to 1000  $\Omega$ .

OVC function is unavailable for 1000 M $\Omega$  range.

- When bias voltage compensation function has been changed, the zero adjustment function is released.
- When inductance of the measured object is large, delay time needs to be adjusted. (Initially set delay time to be longer, and then gradually reduce the measurement while observing the measurement.
- When measured heat capacity of the object is small, the effect of the bias voltage compensation function may not be seen.
- When low current resistance measurement is ON, the bias voltage compensation function automatically turns ON at all ranges, and this function cannot be released.

## 3.9 Display Digit Setting

### 1. Select parameter setting page



Press **[PAGE]** Button  
to parameter setting page

### 2. Select related menu items

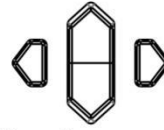
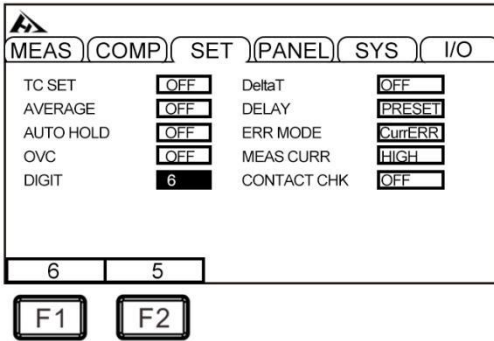

Press the up, down, left and right keys to select the value to be set

[F1] key: 6 digits (1,000,00dgt.) (initial setting)

[F2] key: 5 digits (100,00dgt.)

## 3.10 Test Current Setting

### 1. Select parameter setting page



Press **[PAGE]** Button to parameter setting page

### 2. Select related menu items

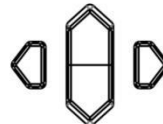
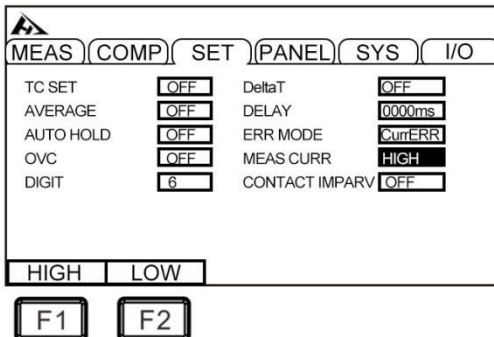

Press the up, down, left and right keys to select the value to be set



Range	High current		Low current	
	Test current	Maximum measuring range of power	Test current	Maximum measuring range of power
20 mΩ	1 A	22 mW	-	
200 mΩ	1 A	220 mW	100 mA	200 mΩ
2000 mΩ	100 mA	22 mW	10 mA	2000 mΩ
20 Ω	10 mA	2.2 mW	1 mA	20 Ω
200 Ω	10 mA	22 mW	1 mA	200 Ω
2000 Ω	1 mA	2.2 mW	-	
20 kΩ	500 μA	5.5 mW	-	
200 kΩ	50 μA	550 μW	-	
2000 kΩ	5 μA	55 μW	-	
10 MΩ	1 μA	12 μW	-	

When the power of the resistance value  $\times$  (measurement current)<sup>2</sup> is applied to the object to be measured and the following problems are caused by test current, set test current to low current.

- The object to be tested is blown
- The measured object is hot and the resistance value changes.
- The object to be measured is magnetized and inductance changes.

## 3.11 Contact Detection Settings

Check for poor contact between test object and probe or the disconnection status of the test cable.

### 1. Select parameter setting page



Press **[PAGE]** Button to parameter setting page

### 2. Select related menu items

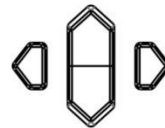
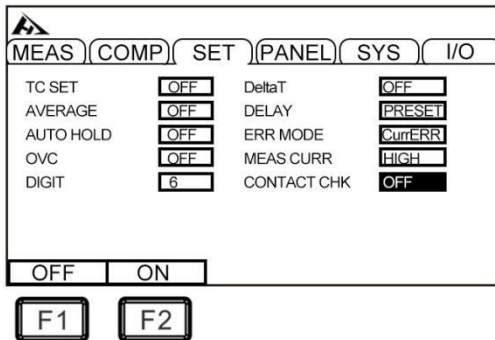

Press the up, down, left and right keys to select the value to be set

During period from response time to measurement period, instrument always monitors resistance between SOURCE A - SENSEA and SOURCE B - SENSE B. When resistance value exceeds threshold, it is judged as a contact error. When a contact error occurs, CONTACT TERM.A and CONTACT TERM.B errors are displayed. The comparator judgment of measured value is not performed. When this error is displayed, check the contact of probe and disconnection of test cable. The object to be measured is a conductive paint, conductive rubber, etc. When the resistance between SENSE-SOURCE is too large, it will always be in an error state and measurement will not be possible. In this case, set the touch detection function to OFF.

## 4.1 Comparator Function

Before using the comparator function, when the range is exceeded (displays OvrRng) and when the test is abnormal (CONTROLTION TERM or - - - - - is displayed), the judgment of the comparator is displayed as shown below

If the power is turned off during setup, the value being set becomes invalid and becomes the previous setting value. To confirm the settings, press [ENTER] key.

The initial setting sets the comparator function to OFF. When the function is set to OFF, even if the parameter value of the comparator is set, it is an invalid value. Press [COMP] button to turn comparator on/off.

**Measurement page when the comparator function is turned on**

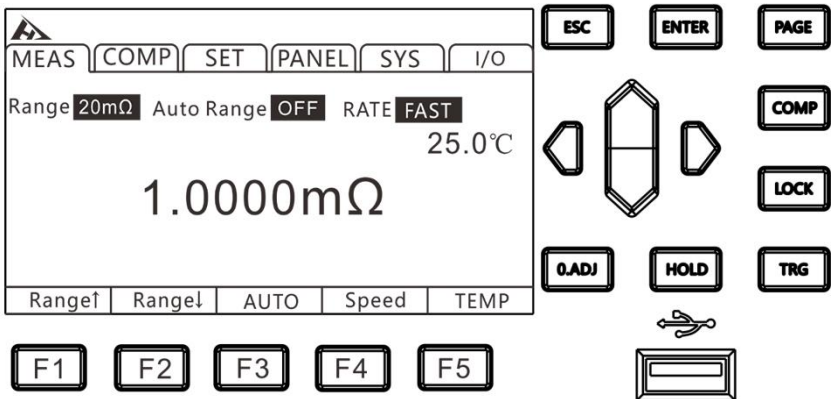

Measured value display	Comparator decision display (COMP Indicator)
+OvrRng	Hi
- OvrRng	Lo
CONTACT TERM or - - - - -	Extinguished (no decision)

- If  $\Delta T$  or multi-step sorting function is set to ON, comparator function is automatically turned OFF.
- The range cannot be changed while using the comparator function. To change the range, use the change on comparator setting screen. To use auto range, set comparator function to OFF.

### 4.1.1 Comparison Result Signal Output Method

When comparator function is turned on, the instrument provides 3 alarm outputs.

1. Panel LED light alarm
- 2.

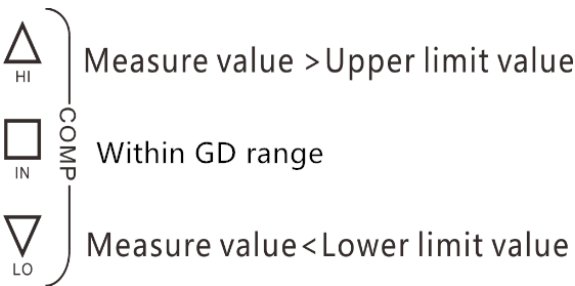

3. Beep alarm

## 2.1 Select parameter setting page



Press **[PAGE]** Button to COMP setting page

## 2.2 Select related menu items

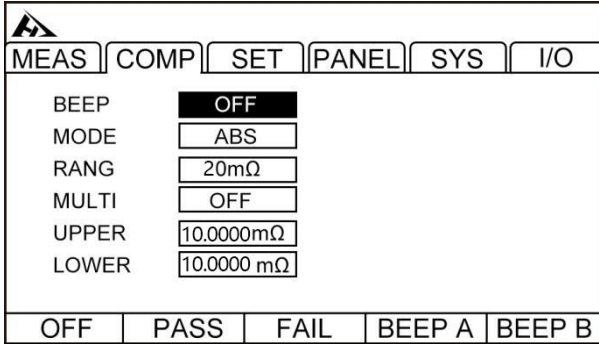

## 3. External IO port, signal output (refer to Chapter 9)

### 4.2 Comparison Mode

#### 4.2.1 Absolute Value Mode

##### 1. Select parameter setting page



Press **[PAGE]** Button to COMP setting page

##### 2. Select related menu items

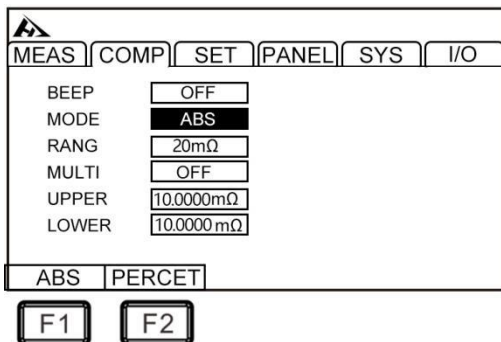

Press the up, down, left and right keys to select the value to be set

### 3. Upper limit setting

Press [F1] input key, use left and right cursor keys to move cursor to the position to be set, and use up and down cursor keys to change value.

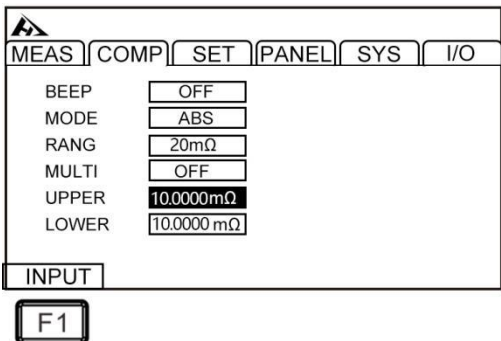

Press the up, down, left and right keys to select the value to be set

Press [F1] input key, use left and right cursor keys to move cursor to the position to be set, and use up and down cursor keys to change value.

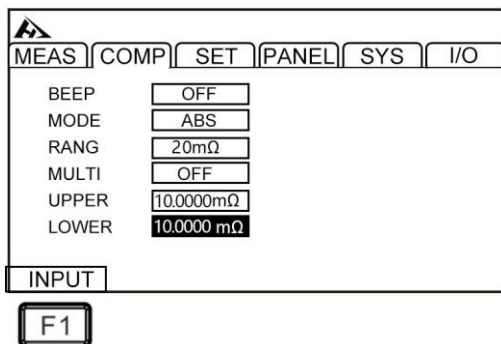

Press the up, down, left and right keys to select the value to be set

To interrupt setting, press [ESC] key to return to original page.

[Upper and lower limit comparison]

Example:

Absolute value mode	Upper limit value	Lower limit value	Pass	Fail
Comparison of upper and lower limits	100Ω	10Ω	$10\Omega \leq \text{test value} \leq 100\Omega$	test value > 100Ω or test value < 10Ω

## 4.2.2 Percentage Mode

1. Select parameter setting page



Press [PAGE] Button to COMP setting page

2. Select related menu items

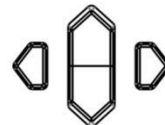
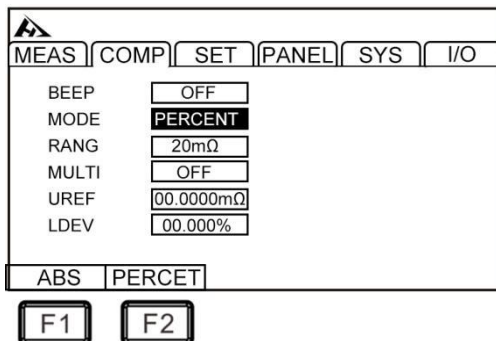

Press the up, down, left and right keys to select the value to be set



### 3. Standard value setting

Press [F1] input key, use left and right cursor keys to move cursor to the position to be set, and use up and down cursor keys to change value.

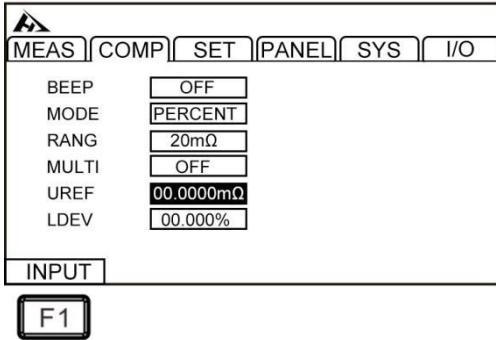

Press the up, down, left and right keys to select the value to be set

### 4. Deviation value setting

Press [F1] input key, use left and right cursor keys to move cursor to the position to be set, and use up and down cursor keys to change value.

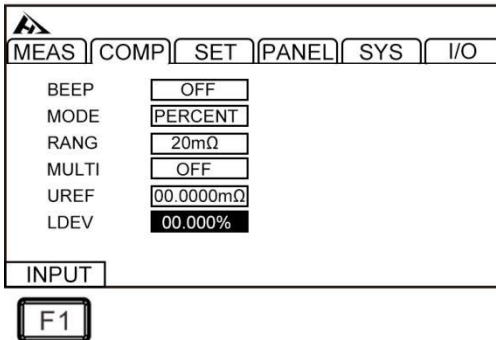

Press the up, down, left and right keys to select the value to be set

To interrupt setting, press [ESC] key to return to the original page.

If percentage mode is set, the measured value becomes deviation display (%).



$$\text{Relative Value (tolerance)} = \left( \frac{\text{Measured Value}}{\text{Reference Value}} - 1 \right) \times 100[\%]$$

Display range: -99.999% ~ +99.999%

The standard value is 10 mΩ, set the allowable range relative to the standard value to ± 1%.

## 4.3 Multi-bins Sorting Function

A comparison judgment is made between top measurement (absolute value mode) or the standard deviation (percent mode) in one measurement by classification in 1 test up to 10 sets of upper and lower limits, and the measurement result is displayed. All items listed for BIN are judged as NG. The sorting result can also be output via EXT I/O terminal.

### 4.3.1 Sorting Function Turn on Settings

1. Select parameter setting page



Press **[PAGE]** Button  
to COMP setting page

2. Select related menu items

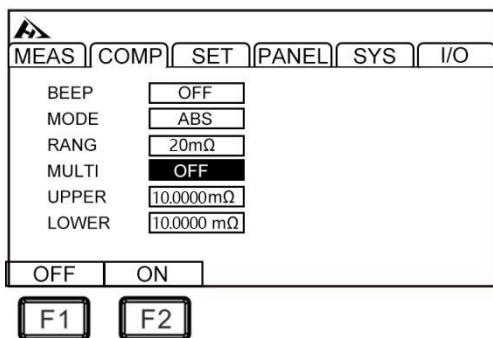

Press the up, down, left and right keys to select the value to be set

Note:

- The comparator cannot be set to ON when multi-bins sorting function is ON
- If  $\Delta T$  is set to ON, classification measurement function is automatically turned OFF.
- To use auto range, set multi-bins sorting function to OFF.

## 4.3.2 Sorting Function Range Setting

In multi-bins sorting open page, press up and down keys to select the mode and change the range.

**Range:**

20mΩ ↔ 200mΩ ↔ 2000mΩ ↔ 20Ω ↔ 200Ω ↔ 2000Ω ↔  
20kΩ ↔ 200kΩ ↔ 2000kΩ ↔ 10MΩ

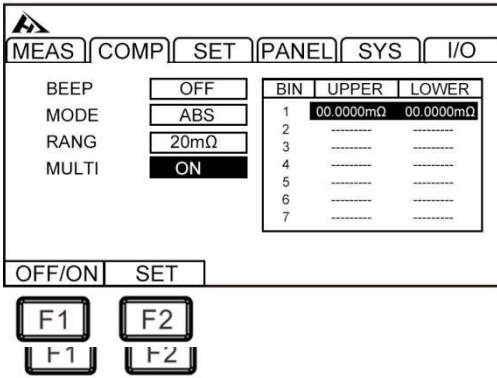

Press the up, down, left and right keys to select the value to be set

### 4.3.3 Sorting Function Upper and Lower Limit Settings

After select absolute value mode and determine range, the corresponding upper and lower limits can be set, unit for upper and lower limit units are consistent with the range.

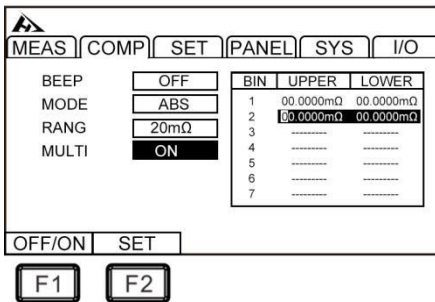

Press the up, down, left and right keys to select the value to be set

### 4.3.4 Sorting Function Standard Difference Value Setting

After selecting percentage mode and determining the range, users can set the corresponding standard value and deviation value. The standard value and deviation value unit are consistent with range.

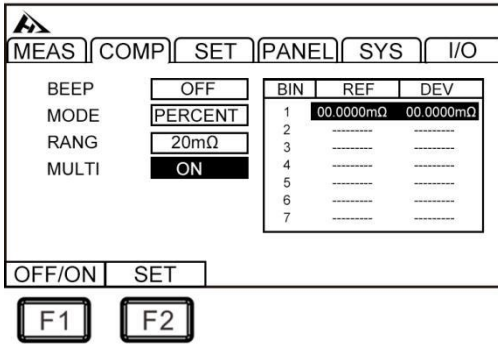

Press the up, down, left and right keys to select the value to be set

## Chapter 5 Measurement

This chapter provides a step-by-step description of the functions used for proper measurement, including start-up settings, range scope, protection function start-up and zero adjustment.

### 5.1 Start Test

1. Set relevant parameters
2. Connect test leads correctly
3. Start measurement

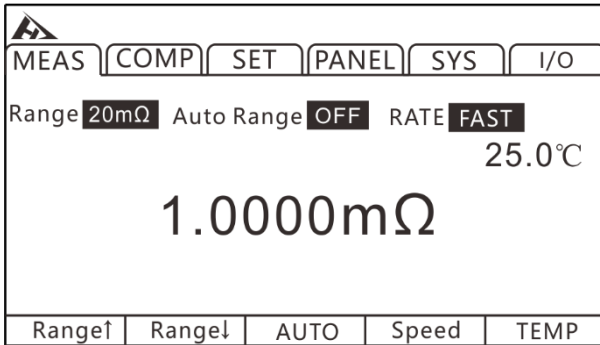

Trigger Mode	Meaning
<b>Internal trigger</b>	Automatic trigger test inside the instrument
<b>External trigger</b>	Trigger test via external EXT IO terminal TRG signal

**Note:**

- Users cannot start another test again when the test has not ended.
- When the EOC signal at EXT I/O port is LOW, the test cannot be triggered.

## 5.2 Measuring Value Display

The following is test range. Once the following range is exceeded, OF is displayed (overrange)

Test current and range maximum display value:

Resistance range	Measurement current		Maximum display value	Resolution (Ω)
20mΩ	1 A		22.0000mΩ	0.1μΩ
200mΩ	High	1 A	220.000mΩ	200mΩ
	Low	100 mA		

2000mΩ	High	100 mA	2200.00mΩ	2000mΩ
	Low	10 mA		
20Ω	High	10 mA	22.0000Ω	20Ω
	Low	1 mA		
200Ω	High	10 mA	220.000Ω	200Ω
	Low	1 mA		
2000Ω	1 mA		2200.00Ω	10mΩ
20kΩ	500 μA		22.0000kΩ	0.1Ω
200kΩ	50 μA		220.000kΩ	1Ω
2000kΩ	5 μA		2200.00kΩ	10Ω
10MΩ	1 μA		12.0000MΩ	0.1kΩ

### 5.3 Automatic Protection Function

If an overvoltage is input to measurement terminals, the internal circuit protection function of the instrument is activated. If users input an overvoltage incorrectly, immediately remove test leads from the object under test. Measurements cannot be made during protection function. To release protection function, touch or connect DRIVE+ and DRIVE- of the test leads or reconnect power.

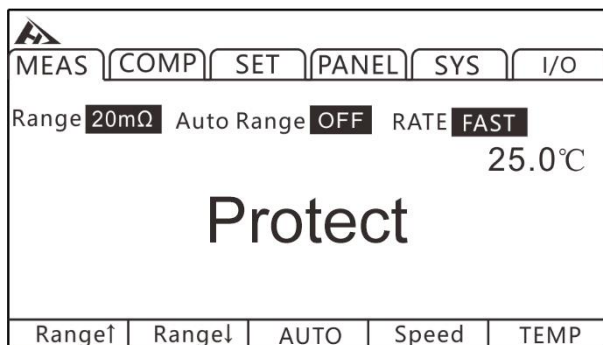

## 5.4 Perform Clear Zero

Please perform clear zero in the following cases:

- When to improve test accuracy
  - When zero is not adjusted due to the range, addition accuracy is included.
- When residual display contents appear due to influence of electromotive force, etc.
  - Adjust display to zero.
- When it is difficult to perform 4-terminal wiring (Kelvin connection)
  - Cancel the remaining resistance of 2 terminal wiring.

note:

- After zero adjustment has been made, if ambient temperature changes or the test leads are changed, perform clear zero again.
- Perform clear zero for all ranges used. In manual range, clear zero is performed only in the current range; in automatic range, clear zero is performed on all ranges.
- When clear zero is performed in auto range, if delay time is insufficient, zero adjustment cannot be completed normally. In this case, please perform zero adjustment under manual range.
- The zero value is stored internally even when power is turned off, and is also saved to the panel. Sometimes it may not be possible to read the zero value from the panel.
- When offset voltage compensation function (OVC) is switched from ON to OFF or from OFF to ON, zero adjustment is released. Please perform zero adjustment again.
- Set the 0ADJ signal of EXT I/O to ON (short-circuit to ISO\_COM terminal of EXT I/O connector), or perform zero adjustment.
- Although resistance of each range -1%f.s. to 50%f.s. can be canceled, please control it as much as possible within 1%f.s.

## 5.4.1 Perform Clear Zero

1. Short circuit test leads

CHT9344 Test clip type test leads

**Correct:**

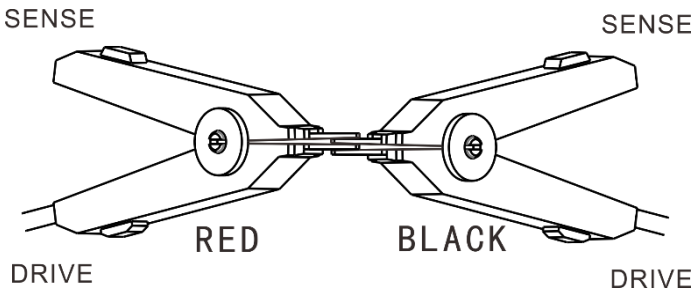

**Wrong:**

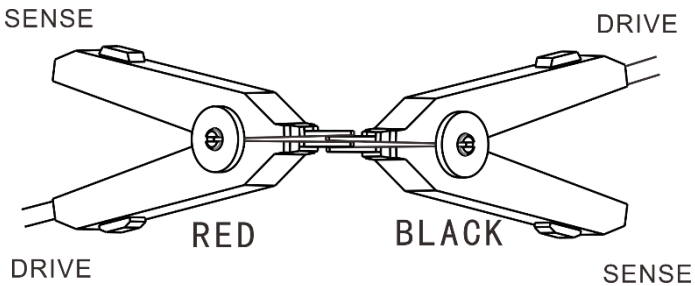



CHT9363-B Probe type test leads

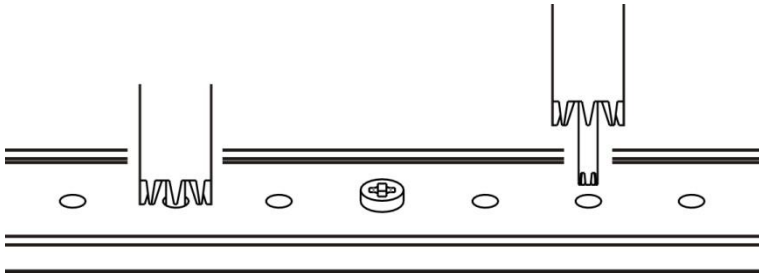

2. Confirm that measured value is within 1%f.s.

When measured value is not displayed, please confirm that the test leads are wired correctly.

**Screen when wiring is correct:**

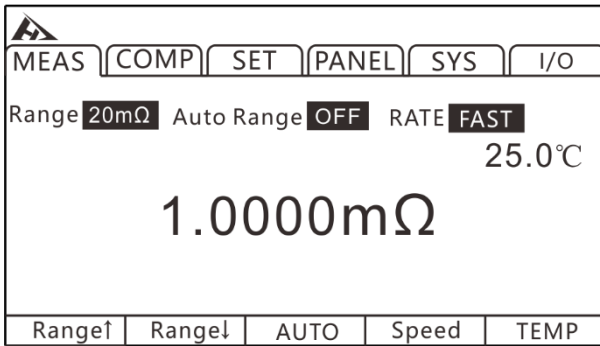

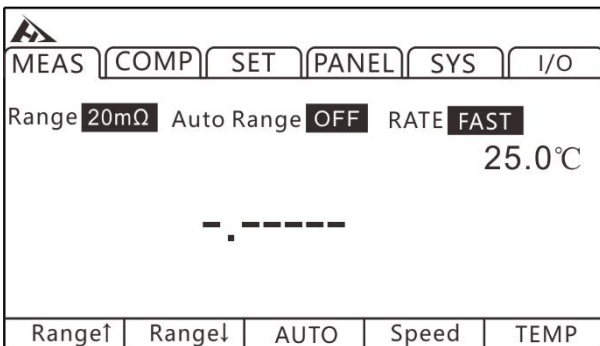

**Screen when wiring is wrong:**

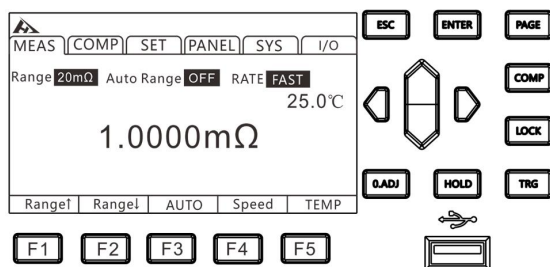



3. Press [0.ADJ] to clear zero

#### 4. After performing zero adjustment

If clear zero is successful, the icon  will be displayed in the lower right corner of the display measurement and then return to measurement interface. If zero adjustment failed, the icon  will not be displayed, and measurement page is returned.

#### Zero adjustment failed

When zero adjustment is not possible, it may be that the measured value before zero adjustment exceeds  $\pm 1\%$  of each range, or it is in a test abnormal state. Please make correct wiring again and re-zero. When resistance value of a self-made cable is high, since it cannot be zeroed, reduce the wiring resistance.

Note:

When zero adjustment fails, zero adjustment of the current range will be released.

#### 5. Release clear zero

On measurement page, press and hold [0.ADJ] button to release zero value of the current range.

## Chapter 6 Measurement Panel Save

All measurement conditions can be saved, retrieved or deleted in the form of a file. Press [PAGE] to select the panel save page.



Press [PAGE] Button to Panel page

After entering this page, press up and down keys to view the saved record, users can also make performing of save, load, clear, and rename the current record.

### 6.1 Save Panel Setting

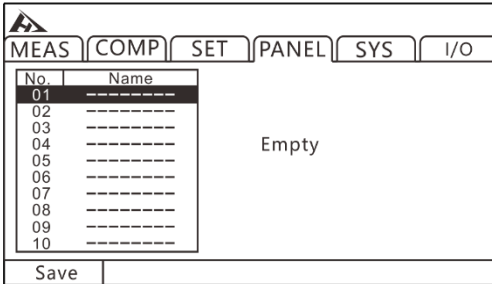

Press up/down/left/right to choose the parameter



Use up and down keys to browse the current settings and press [F1] key to save the current settings.

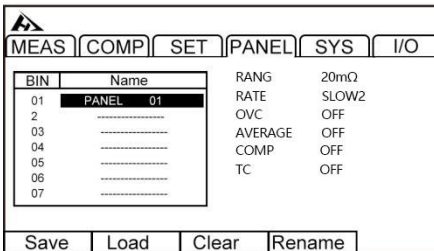

Press the up, down, left and right keys to select the value to be set



## 6.2 Retrieve Measurement Settings

BIN	Name	RANG	10MΩ
01	PANEL 01	RATE	SLOW2
02			
03			
04			
05		COMP	OFF
06		TC	OFF
07			

Save Load Clear Rename

Pree **F2** Select load

Pree **enter** Select load



Use up and down keys to view through the current settings and press load button to retrieve the current settings.

## 6.3 Delete Measurement Settings

BIN	Name	RANG	10MΩ
01	PANEL 01	RATE	SLOW2
02			
03			
04			
05		COMP	OFF
06		TC	OFF
07			

Save Load Clear Rename

Pree **F3** Clear choice

Pree **enter** Clearly defined



Use up and down keys to browse the current settings and press clear key to delete the current settings.

## 6.4 Rename Measurement Settings

BIN	Name	RANG	10MΩ
01	PANEL 01	RATE	SLOW2
02			
03			
04			
05		COMP	OFF
06		TC	OFF
07			

Save Load Clear Rename

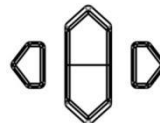

Press the up, down, left and right keys to select the value to be set



Use up and down keys to browse the current settings and press rename button to modify the current file name.

## 7.1 Button Sound Setting

Users can choose whether to turn on button sound when operating the instrument keys.

1. Select parameter settings page



Press **[PAGE]** Button to SYS page

2. Select related menu items

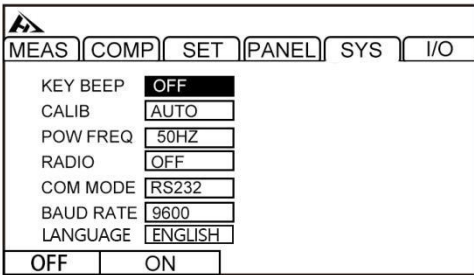

Press the up, down, left and right keys to select the value to be set



Press **[F1]** to turn off button sound, press **[F2]** to turn on button sound.

## 7.2 Self-calibration Function

To maintain test accuracy, self-calibration function compensates for bias voltage and gain drift inside the circuit.

## 1. Select parameter settings page



Press **[PAGE]** Button to SYS page

## 2. Select related menu items

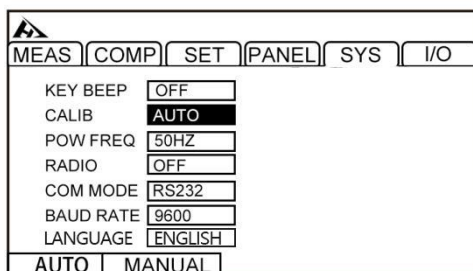

Press the up, down, left and right keys to select the value to be set



Press [F1] to set to Auto. During TRG standby, self-calibration of 5ms is performed for every 1 second. During 5ms self-calibration, if TRG signal is received, self-calibration will stop, and the measurement will start after 0.5ms. When the measurement time is deviated, please set it to manual.

Press [F2] to set to manual. The calibration time is about 400ms. It is executed at any timing and cannot be automatically executed at timing except the scheduled one. When setting to manual, if temperature of the use environment is changed by 2 °C or higher, be sure to perform self-calibration (the accuracy cannot be guaranteed when it is not executed). When temperature change of the use environment is 2 °C or less, please perform self-calibration at intervals of 30 minutes or less.

## 7.3 Power Frequency Setting

There are 3 power modes, [50Hz] / [60Hz] / [Auto]. The correct power frequency setting can effectively filter out the noise caused by the power supply frequency. If the power frequency is set incorrectly, the measurement may be unstable.

If users do not know the current power supply frequency, please select the [Auto] option. The [Auto] option will not take effect until it is rebooted.

### 1. Select parameter settings page



Press **[PAGE]** Button to SYS page

### 2. Select related menu items

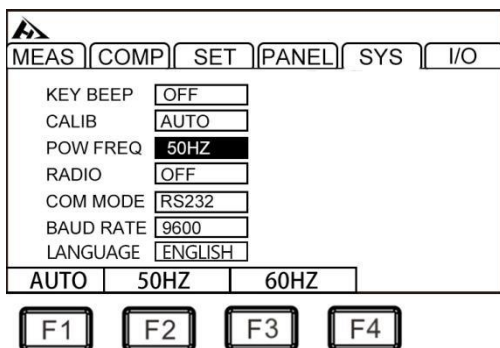

Press the up, down, left and right keys to select the value to be set

#### Note:

When power frequency is in [Auto] mode, sometimes there is power frequency automatic capture failure due to environmental noise, and lead to measurement unstable. In this case it is recommended to manually select the power frequency.

## 7.4 Radio Mode Setting

Press [F1] to turn it off, press [F2] to turn it on

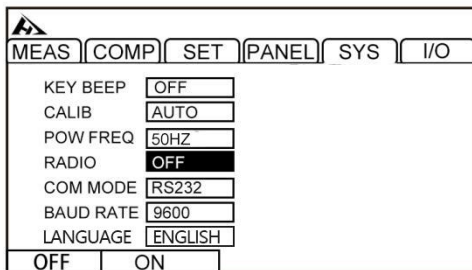

Press the up, down, left and right keys to select the value to be set



## 7.5 Communication Mode

Communication mode is divided into RS232 and LAN (Ethernet protocol uses TCP protocol), all adopt SCPI protocol format.



**Do not connect communication port to the test port, because this will damage the instrument.**

### 7.5.1 RS232 Communication Mode

RS232 communication method uses 3-wire communication.

#### Interface and cable

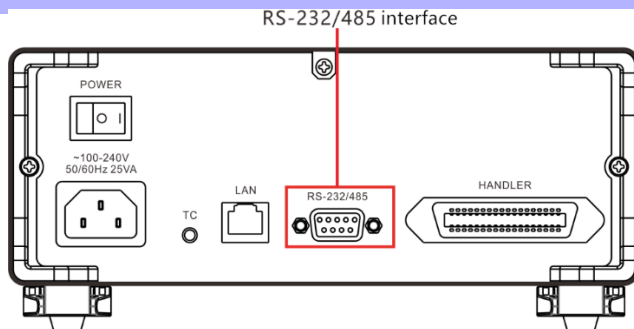



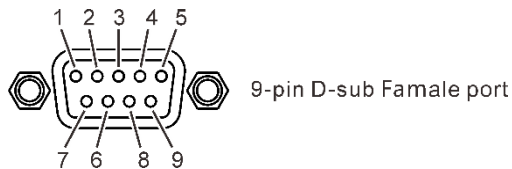

## RS232 Connection Method

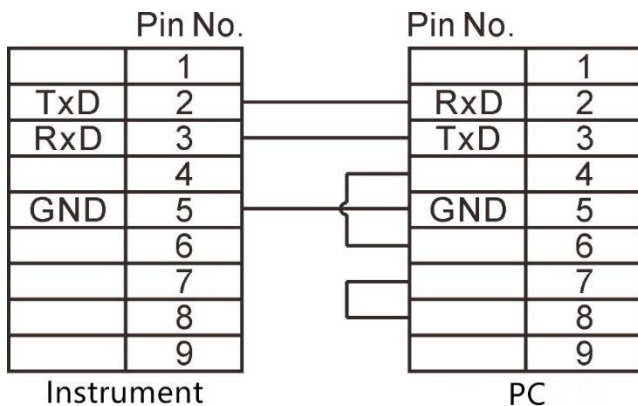

## RS232 Communication Setting

1. Select parameter setting page



Press **[PAGE]** Button to SYS page

2. Select related menu items

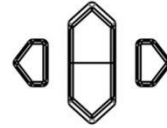
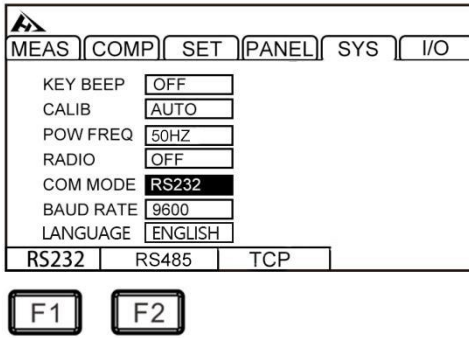

Press the up, down, left and right keys to select the value to be set

### 3. Select communication baud rate

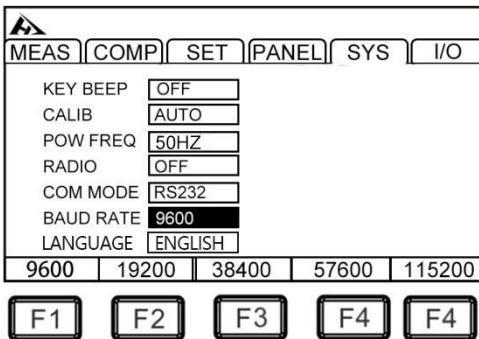

Press the up, down, left and right keys to select the value to be set

## 7.5.2 LAN Protocol

LAN communication uses TCP protocol for communication

### Interface and Cable

Ethernet interface adopts the standard RJ45 port, and cable uses Category 5 of Internet cable.

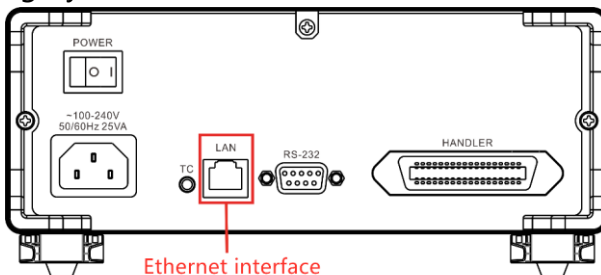

## Connection Method

### 1. Instrument and computer connection

When the instrument is connected to a computer, the network cable uses a crossover cable.

A termination method uses the 568B standard, B termination method uses the 568A standard:

Orange white	Orange	Green white	Blue	Blue white	Green	Gray white	Gray
-----------------	--------	----------------	------	---------------	-------	---------------	------

### 2. Instrument and router connection

When the instrument is connected to a router, the network cable is directly connected.

Both terminals use the 568B standard:

Orange white	Orange	Green white	Blue	Blue white	Green	Gray white	Gray
-----------------	--------	----------------	------	---------------	-------	---------------	------

## Setting

### 1. Select parameter setting page



Press **[PAGE]** Button to SYS page

### 2. Select TCP communication mode

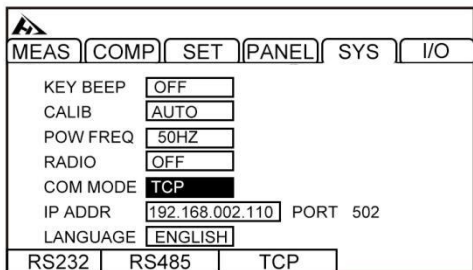

Press the up, down, left and right keys to select the value to be set

### 3. Set communication IP

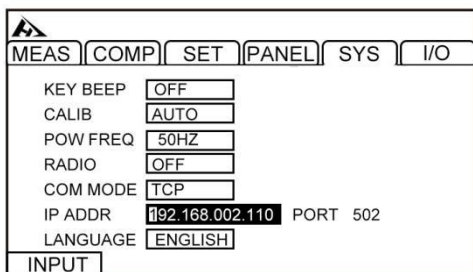

Press the up, down, left and right keys to select the value to be set

## 7.6 USB Interface

The front panel of the instrument has a USB interface and is used as a HOST function. It is used to upgrade programs and save data after inserting a USB flash drive.

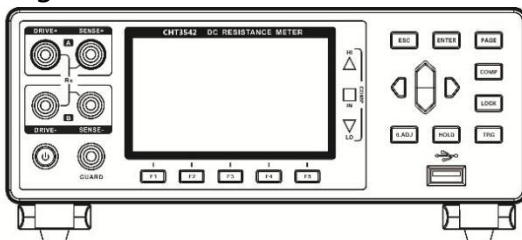
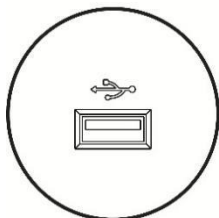

EXT I / O terminal on the rear panel of the instrument supports external control, provides output for test and comparison judgment signals, and accepts input TRG signal. All signals use an optocoupler. All input/output signals can be configured to (NPN) or (PNP) levels via the instrument panel settings. Understanding the internal circuit structure and paying attention to safety issues will help to better connect the control system.

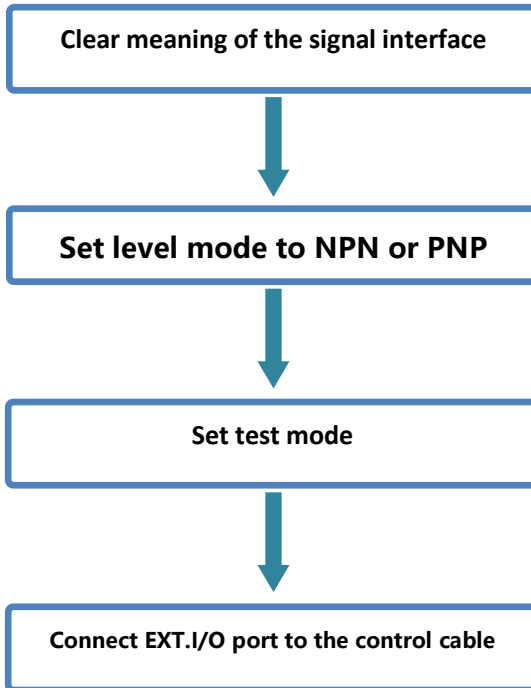

## 8.1 Trigger Source Settings

1. Select I/O page



Press **[PAGE]** Button to I/O page

## 2. Select related menu items

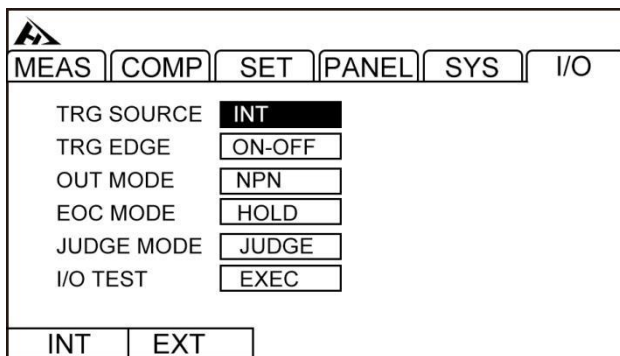

## 3. Press [F2] to select EXT

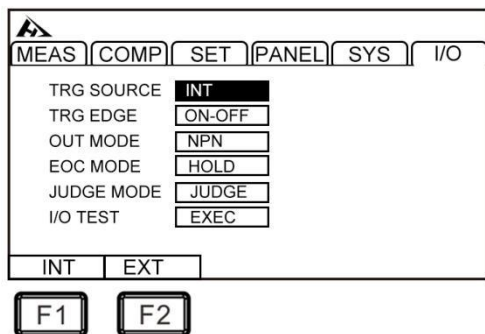

Press the up, down, left and right keys to select the value to be set

## 8.2 Trigger Level Setting

### 1. Select I/O page



Press **[PAGE]** Button to I/O page

## 2. Select related menu items

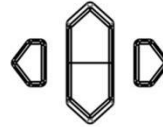
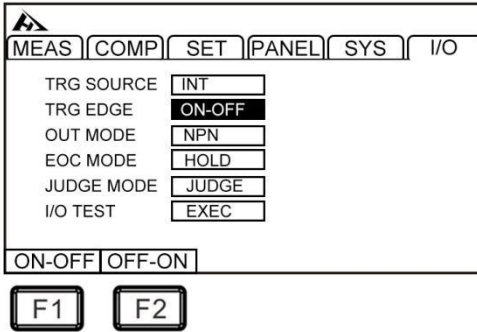

Press the up, down, left and right keys to select the value to be set

## 8.3 Level Mode Setting

### 1. Select I/O page



Press **[PAGE]** Button to I/O page

### 2. Select level mode, press [F1] to set to NPN, and press [F2] to set to PNP.

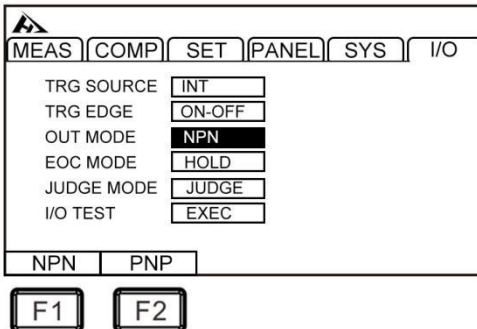

Press the up, down, left and right keys to select the value to be set

# NPN Wiring Method

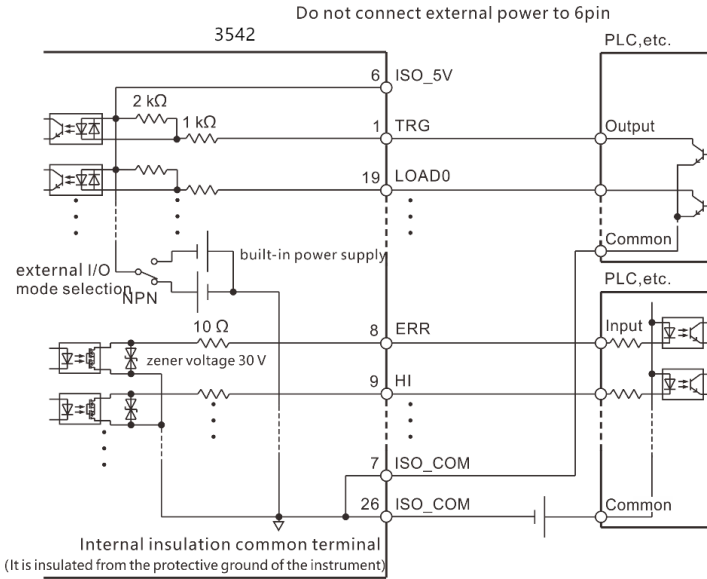

# PNP Wiring Method

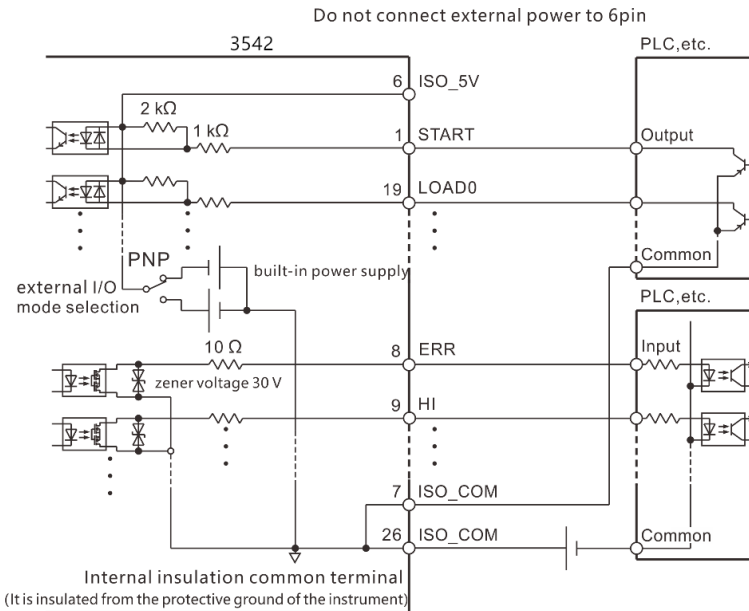



## 8.4 EOC Mode Setting

### 1. Select I/O page



Press **[PAGE]** Button to I/O page

### 2. Select related menu items

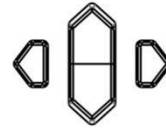
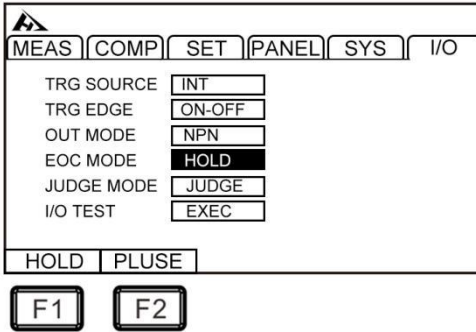

Press the up, down, left and right keys to select the value to be set

### 3. Press [F2] to select pulse

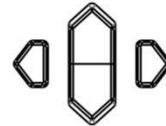
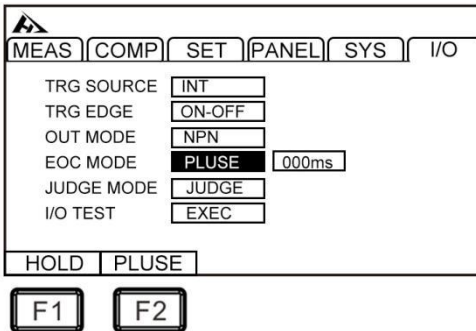

Press the up, down, left and right keys to select the value to be set

### 4. Press [F1] to input time

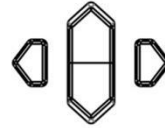
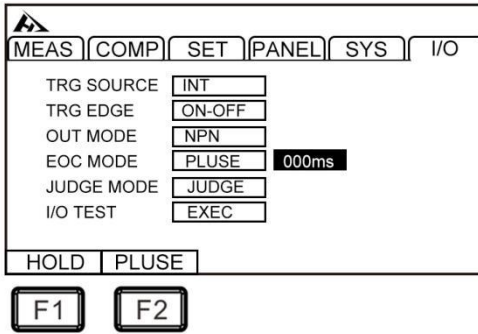

Press the up, down, left and right keys to select the value to be set

## 8.5 Output Mode Setting

The output signal includes decision mode and BCD mode. When using and not using a multiplexer, the output signals of decision mode are different. BCD mode uses other functions by high and low positions (with range information).

### 1. Select I/O page



Press [PAGE] Button to I/O page

### 2. Select related menu items

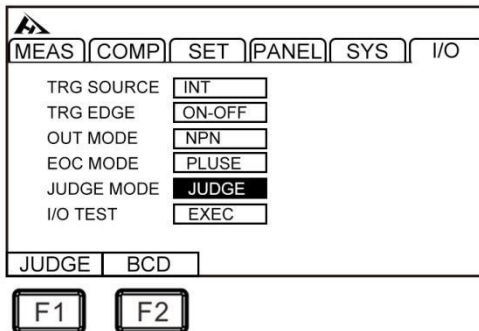

Press the up, down, left and right keys to select the value to be set

### Terminal function under decision mode

Pin	Function
9	ISO_COM
10	ERR
11	HI
12	LO
13	BIN0
14	BIN2
15	BIN4
16	BIN6
17	BIN8
18	OUT0
19	OUT2
28	EOC
29	INDEX
30	IN
31	OB
32	BIN1
33	BIN3
34	BIN5
35	BIN7
36	BIN9
37	OUT1

### Terminal function under BCD mode

Pin	BCD_LOW	
	OFF	ON

9	ISO_COM	
10	ERR	
11	HILO	
12	BCD4-1	RNG_OUT1
13	BCD4-3	RNG_OUT3
14	BCD5-1	BCD1-1
15	BCD5-3	BCD1-3
16	BCD6-1	BCD2-1
17	BCD6-3	BCD2-3
18	BCD7-1	BCD3-1
19	BCD7-3	BCD3-3
28	EOC	
29	BCD4-0	RNG_OUT0
30	IN	
31	BCD4-2	RNG_OUT2
32	BCD5-0	BCD1-0
33	BCD5-0	BCD1-2
34	BCD6-0	BCD2-0
35	BCD6-2	BCD2-2
36	BCD7-0	BCD3-0
37	BCD7-2	BCD3-2

## 8.6 Port Signal Details

## 8.6.1 Port and Signal Description

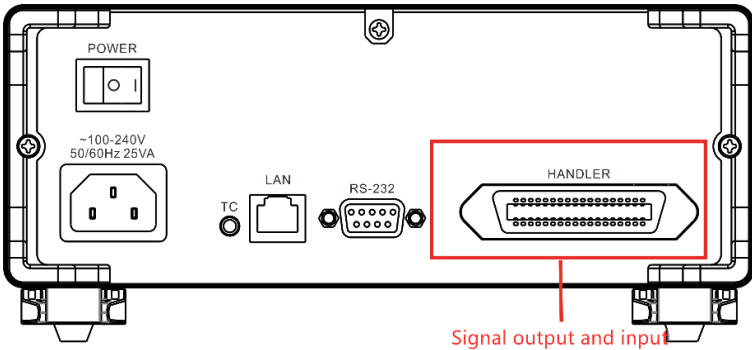

## 8.6.2 Port Diagram

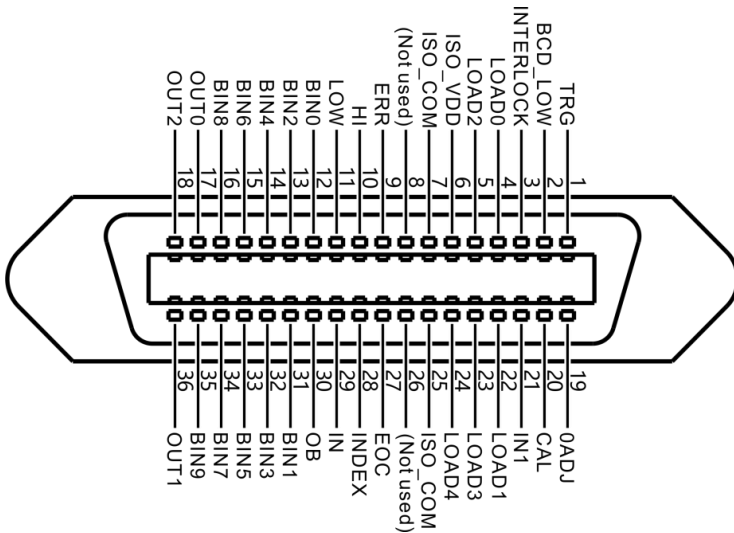

(Instrument Terminal)

PIN	Signal	Function	I/O	Logical mode
1	TRG	External trigger	I	Edge
2	BCD_LOW	BCD low byte output	I	Level
3	INTERLOCK	Key lock	I	Level
4	LOAD0	Panel selection,	I	Level

		channel assignment		
5	LOAD2	Panel selection, channel assignment	I	Level
6	ISO_VDD			
7	ISO_GND			
8	Not used	--	--	--
9	ERR	Abnormal test	O	Level
10	HI	Comparator decision	O	Level
11	LOW	Comparator decision	O	Level
12	BIN0	Sorting P0 bin	O	Level
13	BIN2	Sorting P2 bin	O	Level
14	BIN4	Sorting P4 bin	O	Level
15	BIN6	Sorting P6 bin	O	Level
16	BIN8	Sorting P8 bin	O	Level
17	OUT0	General purpose output Panel selection, channel assignment Panel selection, channel assignment	O	Level
18	OUT2	General purpose output	O	Level
19	0ADJ	Zeroing	I	Edge
20	CAL	Perform self-calibration	I	Edge
21	IN1	Universal input	I	Edge
22	LOAD1	Panel selection, channel assignment	I	Level
23	LOAD3	Panel selection, channel assignment	I	Level
24	LOAD4	Panel selection, channel assignment	I	Level
25	IOS_GND			
26	Not used	--	--	--

27	EOC	End of measurement	O	Level
28	INDEX	End of analog measurement	O	Level
29	IN	Comparator decision	O	Level
30	OB	Sorting NG bin	O	Level
31	BIN1	Sorting P1 bin	O	Level
32	BIN3	Sorting P3 bin	O	Level
33	BIN5	Sorting P5 bin	O	Level
34	BIN7	Sorting P7 bin	O	Level
35	BIN9	Sorting P9 bin	O	Level
36	OUT1	General purpose output	O	Level

### 8.6.3 Port Signal Connection Method

#### Electrical Performance Parameter

Input signal	Input format	Optocoupler insulation, no voltage contact input (corresponding to sink current / pull current output)
	Input ON	Residual voltage 1 V (input ON stream 4 mA (reference value))
Output signal	Input OFF	OPEN (cut current 100 A or less)
	Output form	Optocoupler insulated open-drain output (no polarity)
	Maximum load voltage	DC30 VMAX
	Maximum output current	50 mA/ch
	Residual	1 V or lower (load current 50

	voltage	mA) / 0.5 V or lower (load current 10 mA)
Built-in insulated power supply	Output voltage	Corresponding reverse output: 5.0 V $\pm$ 10%, corresponding source output: -5.0 V $\pm$ 10%
	Maximum output current	100 mA
	Insulation	Insulate from protective ground potential and measuring circuit
	Insulation rating value	Ground voltage DC50 V, AC33 Vrms, AC46.7 Vpk or less

## 8.6.4 Input Circuit Connection

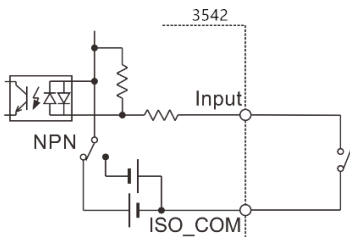

switched input

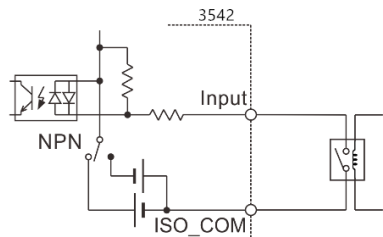

relay input

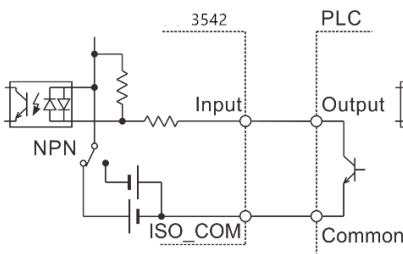

PLC's NPN output

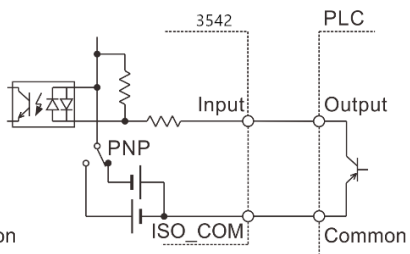

PLC's PNP output



## 8.6.5 Output circuit connection

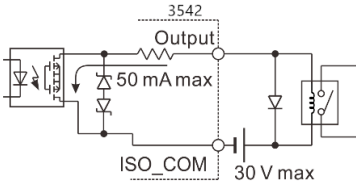

Drive relay

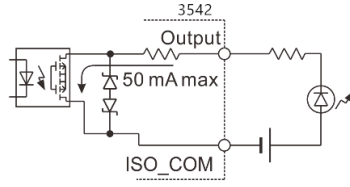

Drive LED lamp

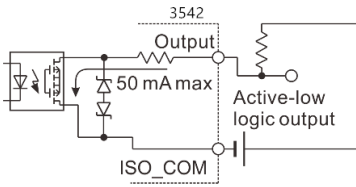

Logic level output

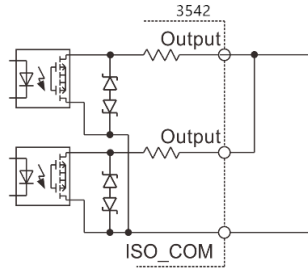

Level or operation

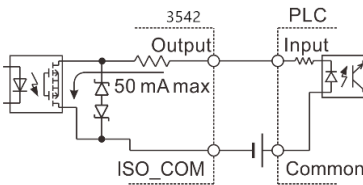

PLC's PN input

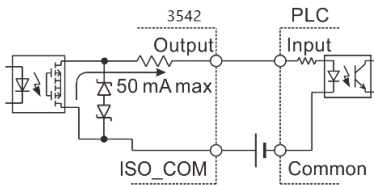

PLC's NP input

## 8.7 Timing Diagram

The level of each signal indicates ON/OFF state of the contact, and pull current (PNP) setting value is the same as the voltage level of EXT I/O terminal. The voltage level High in the sink current (NPN) setting is opposite to Low.

### 8.7.1 Timing Diagram for External Trigger

# (1) External trigger [EXT] setting (EOC output HOLD)

When OVC is OFF

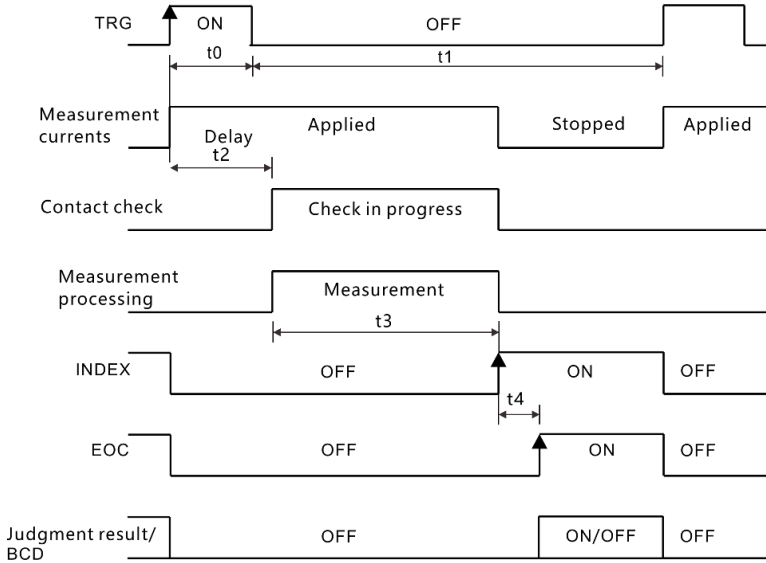

Judgement result /BCD : HI, IN, LO, ERR, BCDm-n, RNG\_OUT0 ~ 3

When OVC is ON

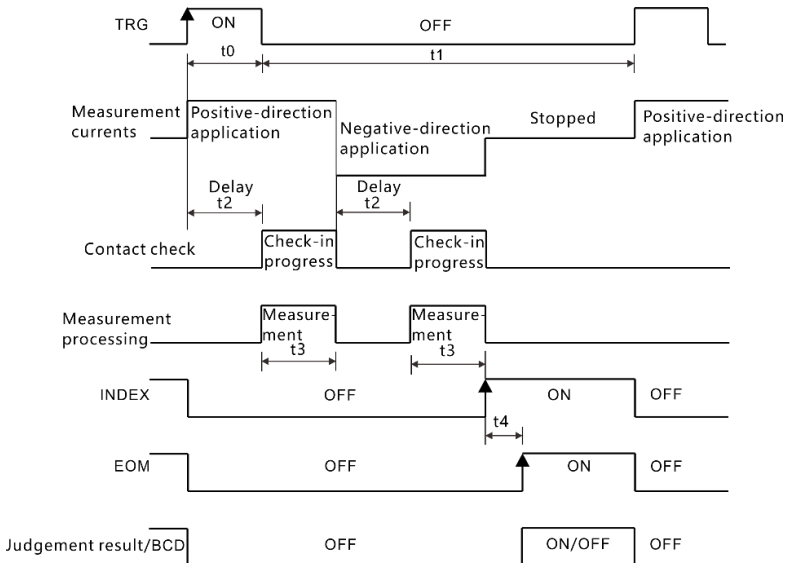

Judgement result /BCD : HI、 IN、 LO、 ERR、 BCDm-n、 RNG\_OUT0 ~ 3

## (2) External trigger [EXT] setting (EOC output PULSE)

At the end of measurement, EOC signal turns ON, if it is set to EOC pulse width ( $t_5$ ), it returns to OFF status.

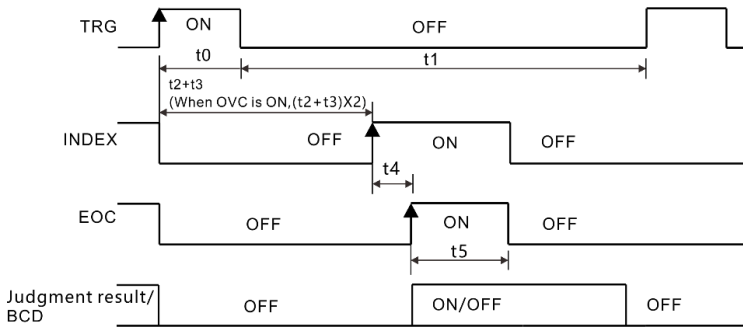

Judgement result /BCD : HI、 IN、 LO、 ERR、 BCDm-n、 RNG\_OUT0 ~ 3

## Timing diagram time description

## 8.7.2 Read Flow When External Trigger

The following shows the flow from start of measurement to measurement value when using external trigger.

EOC signal is output immediately after the instrument determines judgment result (HI, IN, LOW, ER, GD, NG). When response of the controller input circuit is slow, it takes a wait time from detecting ON of EOC signal to reading the determination result.

Item	Content	Time	Remark
t0	Trigger pulse ON time	>0.1 ms	Optional ON/OFF edge
t1	Trigger pulse OFF time	>1 ms	
t2	Delay	0 ~ 100 ms	According to the settings
t3	Read processing time	Integration time + internal waiting time	
t4	Operation time	0.3 ms	Delay when statistical operation and storage function are ON
t5	EOC pulse width	1 ~ 100 ms	According to the settings

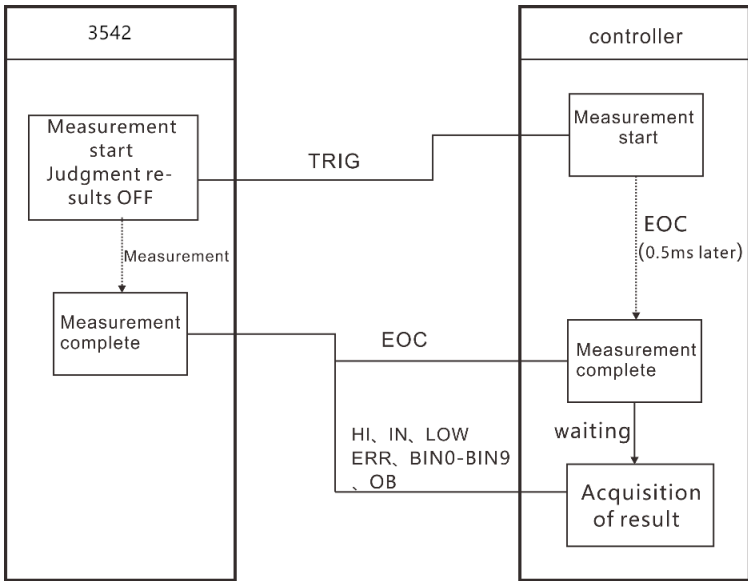

## 8.8 Timing Diagram External Control Confirmation

The level of each signal indicates ON/OFF status of the contact, and pull current (PNP) setting value is the same as the voltage level of EXT I/O terminal. The voltage level High in the sink current (NPN) setting is opposite to Low.

1. Select I/O page



Press **[PAGE]** Button to I/O page

2. Select I/O test

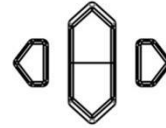
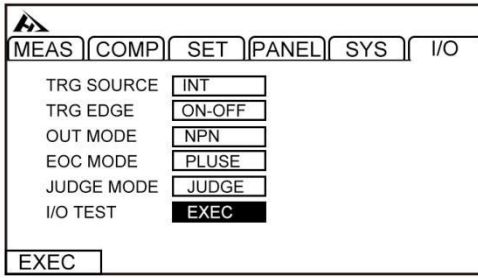

Press the up, down, left and right keys to select the value to be set

### 3. Select I/O test page

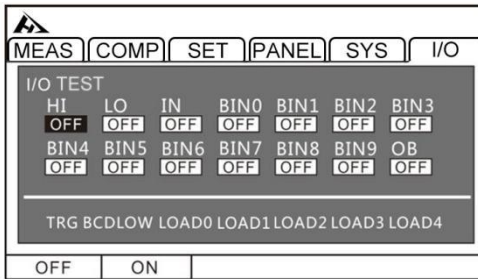



Press the up, down, left and right keys to select the value to be set

Output signal, operable signal (OFF: turn off output, ON: turn on output)

Input signal, display status of the signal (ON: reverse display, OFF: normal display)

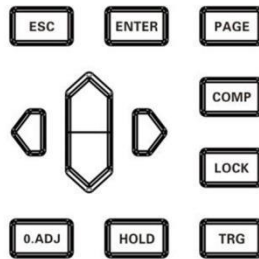
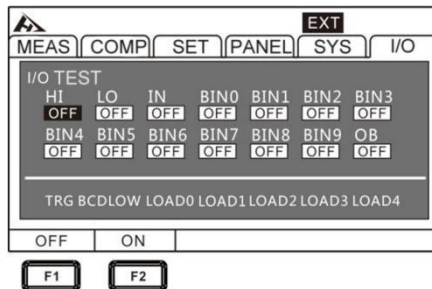
### 4. Exit I/O test page



 Return to the I/O settings interface

## Chapter 9 Parameter

### 9.1 General Parameters

Test parameters	DC resistance
Test Range	[LP OFF] Range 10mΩ ~ 100 MΩ, 12 ranges [LP ON] Range 1000mΩ ~ 1000 Ω, 4 ranges
Measuring Current	<DC 1A ~ 1Ma, [LP ON] 1mA ~ 5μA
Test Speed	Fast speed (2.2ms); medium speed (50Hz: 21ms, 60Hz: 18ms); Slow speed 1 (102ms); slow speed 2 (202ms)
OVC	Thermoelectric culling function
Input Terminal	Banana plug
Operation Key	Rubber key
Display	3.5-inch TFT
Basic Accuracy	±0.01%rdg.±0.001%f.s.
Precision Guarantee Humidity Range	<23°C±5°C, 80RH
Precision Guarantee Period	1 year
Power Supply	AC 100 ~ 240 V, 50/60 Hz, rated power: 40 VA
Size and Weight	325mm(length) x 215mm (width) x 96 mm (height) 4Kg





## 9.2 Accuracy

Range	Maximum measurement range	Test accuracy (%rdg.+%f.s.)			
		Fast	Medium	Slow 1	Slow 2
20 mΩ	22.0000mΩ	0.060+0.050 (0.060+0.015)	0.060+0.020 (0.060+0.002)		0.060+0.020 (0.060+0.001)
200mΩ	220.000mΩ	0.060+0.0100 (0.060+0.003)	0.060+0.010 (0.060+0.001)		0.060+0.010 (0.060+0.001)
		0.014+0.050 (0.014+0.015)	0.014+0.020 (0.014+0.002)		0.014+0.020 (0.014+0.001)
2000mΩ	2200.00mΩ	0.012+0.010 (0.012+0.003)	0.012+0.008 (0.012+0.001)		
		0.008+0.050 (0.008+0.015)	0.008+0.020 (0.008+0.002)		
20 Ω	22.0000 Ω	0.008+0.010 (0.008+0.003)	0.008+0.008 (0.008+0.001)		
		0.008+0.050 (0.008+0.015)	0.008+0.020 (0.008+0.002)		
200 Ω	220.000 Ω	0.007+0.005 (0.007+0.005)	0.007+0.002 (0.007+0.001)		0.007+0.001 (0.007+0.001)
		0.008+0.010 (0.008+0.003)	0.008+0.010 (0.008+0.001)		
2000 Ω	2200.00 Ω	0.007+0.005 (0.007+0.005)	0.006+0.002 (0.006+0.001)		0.006+0.001 (0.006+0.001)
20 kΩ	22.000 0kΩ	0.008+0.005	0.007+0.002		0.007+0.001
200 kΩ	220.000kΩ	0.008+0.005	0.007+0.002		0.007+0.001
2000kΩ	2200.00 kΩ	0.015+0.005	0.008+0.002		0.008+0.001
10 MΩ	12.000 0MΩ	0.030+0.005	0.030+0.002		0.030+0.001