

ATTEN



GT-5150 Multifunctional Desoldering Station User Manual

SHENZHEN ATTEN TECHNOLOGY CO., LTD

Contents



Copyright information	2
Description of common icons	2
Essential knowledge for users	2
Safety precautions.....	2
Disclaimer.....	2
Packing list	3
Schematic diagram of the whole equipment	4
Connection mode for the whole equipment	4
Connection steps for the whole equipment	5
Technical parameters	6
Description of working interface	7
Operations of temperature setup.....	8
Parameter setup	10
Total items of parameter setup menu of the host system	11
Host system setup parameters	11
Total items of parameter setup menu of the handle channel	14
Parameter setup menu of the handle channel	15
Connecting mode of the functional ground wire	18
Schematic diagram of the soldering	18
Care and maintenance	19
Product warranty	20
After-sales contact	20
Appendix	21

Copyright information

The design of this product (including internal software) and its accessories is under the protection of relevant state laws. Any violation of the relevant rights of our company will be subject to legal sanctions. Users shall consciously abide by the relevant state laws when using this product.

Description of common icons

Thank you for using our products. Before using the product, please read this manual carefully and pay attention to the relevant warnings and cautions mentioned in this manual.

 Warning	Misuse of this product may lead to serious injury or death to the user.
 Caution	Misuse of this product may lead to serious injury to the user or material damage to the object involved.

Essential knowledge for users

Users are required to have basic knowledge of common sense and electrical operations before using the product. Minors shall use the product under the guidance of a professional or guardian.

[Caution] To avoid damaging the equipment and keep the safety of the operational environment, please read this manual carefully and keep it well before use so that you may read it at any time when necessary.

Safety precautions

To avoid electric shock or injury to the human body or fire hazard, the following basic rules must be observed when using the equipment. In order to ensure personal safety, only parts and accessories approved or recommended by the original factory can be used, otherwise serious consequences may occur!

Warning

When using this product, the soldering pencil/soldering tip, with the temperature up to 150-480 °C, may cause burns to the user or cause a fire due to improper application. So Users shall strictly observe the following rules:

- Keep this product away from flammable materials.
- Keep the product out of children's reach.
- Do not use this product if you are inexperienced or have no sufficient necessary knowledge without the guidance of related personnel.
- Do not use this product under wet environment or with wet hands to avoid electric shock.
- Do not modify this product and its accessories without authorization.
- Please turn off the power when replacing parts and iron tips, and not resume the use until the equipment is completely cooled down.
- Please use the accessories from the original factory when replacing the product parts.
- Make sure to turn off the power switch when the equipment is temporarily stopped or out of use.

Caution

- To ensure the normal operation of this product's ESD function, only three-core power cord shall be used as the host connecting line.
- Smoke will be generated during the soldering operations. So please pay attention to the smoke evacuation.
- Do not play or do other similar dangerous actions during using this equipment, because it can easily lead to injury to others or yourself.
- Do not use this product for purposes other than soldering.
- Do not modify this product and accessories, otherwise the original warranty will be invalidated or damage may occur to the product.
- When plugging and unplugging the power cord and handle plug, please hold the plug body and do not pull the cord.
- Do not hit the product or its accessories too hard during the operation; otherwise damage may occur to the product.

Disclaimer

We will take no responsibility for any personal injury or property damage caused by reasons other than the product quality problem, which may include force majeure (natural disasters, etc.) or personal behavior during the operation of this product.

This manual is organized, compiled and released by SHENZHEN ATTEN TECHNOLOGY CO., LTD. according to the latest product features. We will not responsible for further notice of the subsequent improvement of the product and this Manual.

Packing list



GT-5150 Host

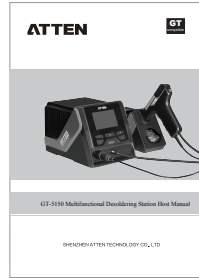

Manual



Power cord



3.5mm ground connector



Product Certificate

GT-5150 packing list

GT-5150 host	1 set	Product Certificate	1 set
Operating manual	1 set	3.5mm ground connector	1 Pcs
Power cord	1 Pcs	GT-X150 desoldering gun	1 Pcs

Optional accessories

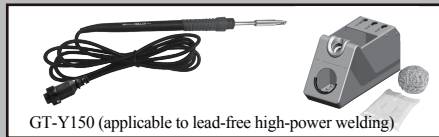

GT-Y150 (applicable to lead-free high-power welding)

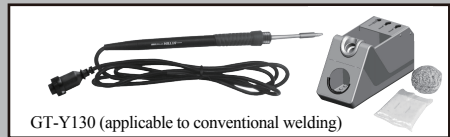

GT-Y130 (applicable to conventional welding)



GT-Y050 (applicable to precision welding)



GT-N100 (applicable to precision welding)

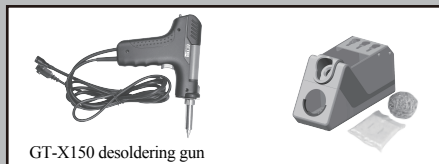

GT-X150 desoldering gun

Schematic diagram of the whole equipment

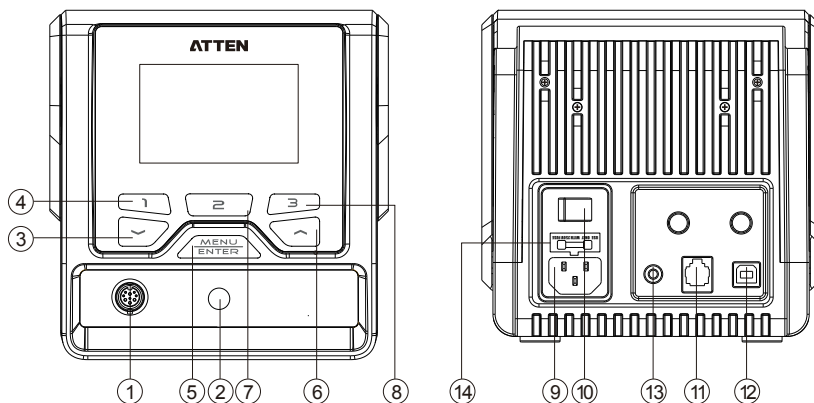

- ① Interface for the soldering tool channel
- ② Vacuum pump interface
- ③ Down arrow key /minus key
- ④ Rapid temperature key 1, Close key of the Interface for the soldering tool channel, Setup menu switch key of the Interface for the soldering tool channel
- ⑤ "Confirm" key, Menu key
- ⑥ Up arrow key /plus key
- ⑦ Rapid temperature key 2, System setup menu switch key
- ⑧ Rapid temperature key 3
- ⑨ Power supply public seat, access rated AC power
- ⑩ Power master switch
- ⑪ RS232 communication interface
- ⑫ USB Communication interface (This function is not available)
- ⑬ Functional grounding interface
- ⑭ Power insurance

Connection mode for the whole equipment

- 1 Connection mode for the whole equipment-GT-5150

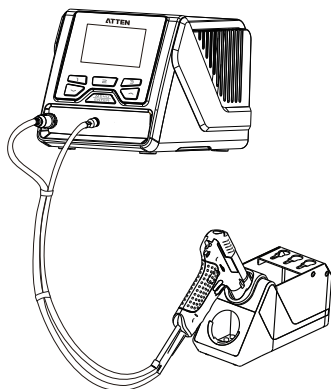

Connection steps for the whole equipment

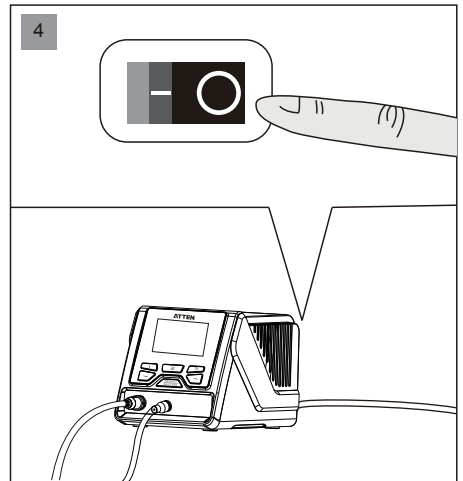
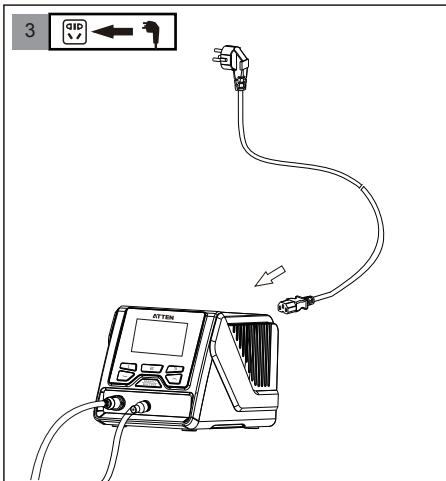
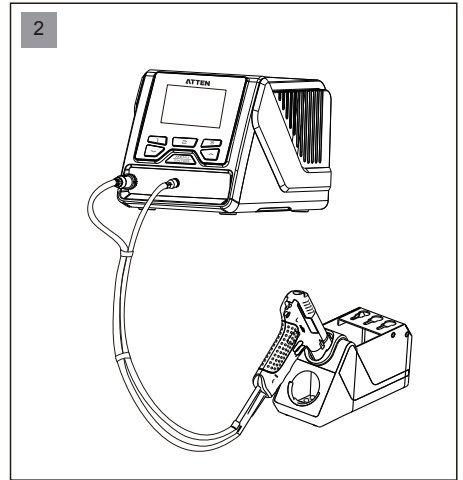
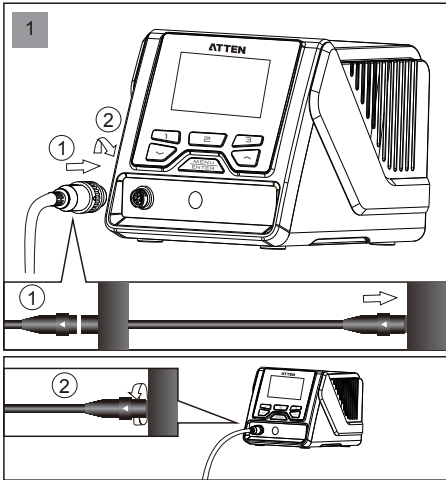

Note

To avoid damaging the host, do not forget to turn off the power when inserting the plug into or removing the plug from the soldering tools!

Technical parameters

Product model	GT-5150
Voltage	AC 230V±10% 50Hz (110V±10% 60Hz)
Power consumption	150W
Security level	Class 1 (Host of the controller) Class 3 (Accessories of soldering handle)
Power fuses	T 2.5A (230VAC) T 3A (110V AC)
Temperature range	250 C ~ 480 C / 482 F ~ 896 F (Configurable temperature range depends on the connected accessories of the soldering handle)
Temperature accuracy	±10 C / ±18 F
Temperature stability	±2 C / ±4 F
Vacuum pressure	-600mmHg
Number of tool channels	1
Functional ground connection	3.5mm plug (which is hard grounding when not connected and is directly connected to the protective ground wire)
Temperature adjustment step	Long press to adjust 10 units at a time, short press to adjust 1 unit at a time
Standby mode	0~120minutes, the default time is 0 minutes, turn off Standby mode
Dormancy mode	0~120minutes, the default time is 0 minutes, turn off Dormancy mode
Rapid temperature	3 groups of temperature, which can be called quickly
Display resolution	240x160 Dots(white letters on blue)
System language	English/Chinese
Communication address range	1~255 (not open yet)
Working conditions	Temperature 0 C ~ 40 C Relative humidity < 80%
Storage conditions	Temperature -20 C ~ 80 C Relative humidity < 80%
Dimension	315 (L) × 252 (W) × 127 (H) mm
Weight	Approximately 4kg

Description of GT-5150 working interface

After connected with charger. Turn-on the power switch. The product will be working normally after the screen display system version for 3 seconds.

GT-5150 startup interface



GT-5150 normal working interface

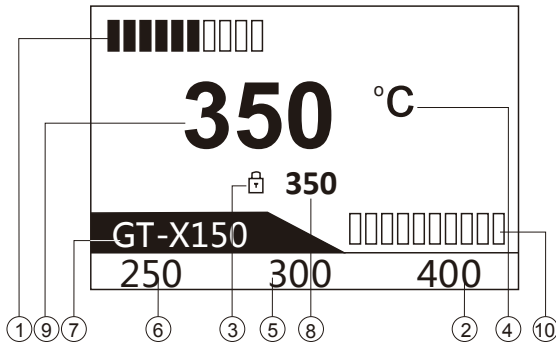

- ① Status display area of channel, display power bar / product working status / abnormal code.
- ② Channel fast temperature 3.
- ③ Fixed temperature icons display.
- ④ Display area of system temperature unit.
- ⑤ Channel fast temperature 2.
- ⑥ Channel fast temperature 1.
- ⑦ Soldering tool model display area of channel.
- ⑧ Set temperature display area of channel.
- ⑨ Actual temperature display area of channel, display of the indicative description of abnormal work conditions.
- ⑩ Vacuum pressure indication (the quantity of solder splash in the solder storage tank is for reference, the indicated value is in direct proportion to the quantity of solder splash in the solder storage tank.)

Operations of temperature setup

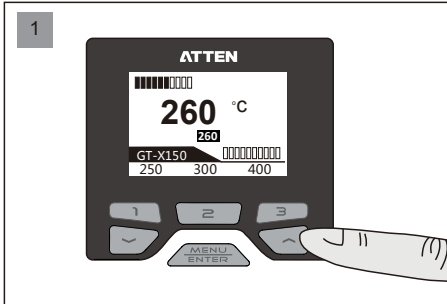

- 1 Press "UP" arrow key to increase the temperature.

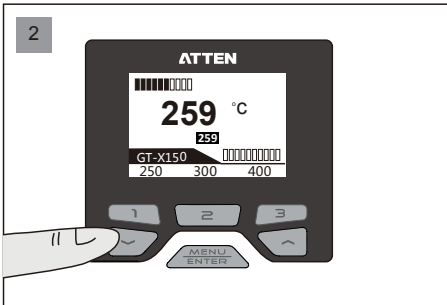

- 2 Press "DOWN" arrow key to decrease the temperature.

Quick temperature call of GT-5150

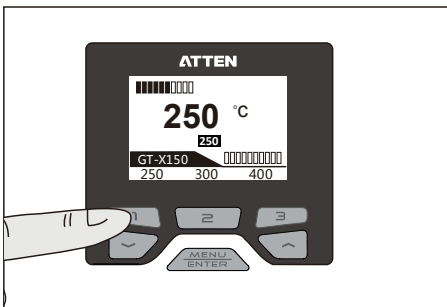

Short press the "1" key to quickly call the set value at 250 °C.

Note: Rapid temperature value can be changed and configured in the channel menu.

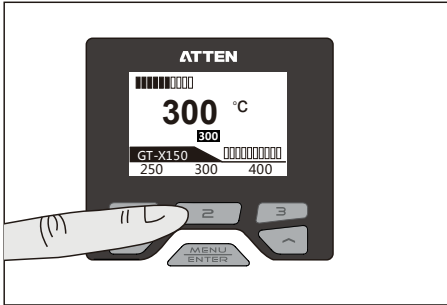

Short press the "2" key to quickly call the set value at 300 °C.

Likely, short press the "3" key to quickly call the set value at 400 °C.

Opening and closing of GT-5150 channels

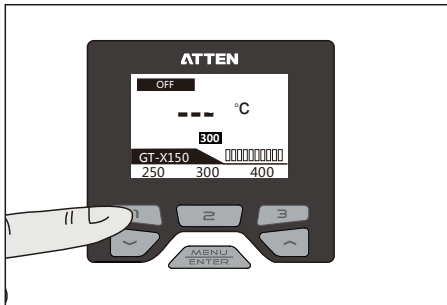

Long press "1" key to open or close channel 1.

Parameter setup

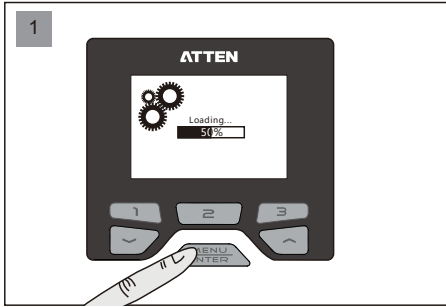

Hold "MENU" key until the load is completed (100%).

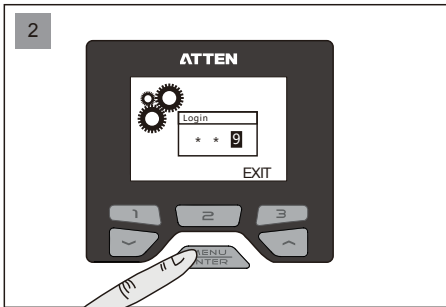

If the configuration page is under the protection of password, the login to "Confirm" page shall be authorized. Press "▲" or "▼" key to change the input value, press "Enter" key to complete one input, press the Rapid temperature key "3". Press the "Logout" key to return to the main interface.

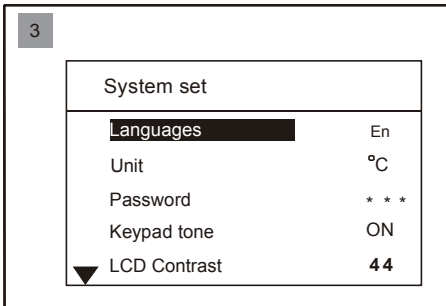

If there is no password protection, or after the correct password is entered, it will jump to the System Parameter setup interface. At this time, the system parameters can be configured.

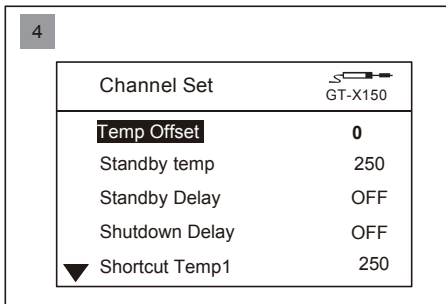

Press the Key 1 to enter channel setup and the Key 2 to switch to system setup.

⚠ Note: Do not change or insert and remove the handle of the soldering tool while setting the channel parameters to avoid damaging the welding accessories and the Host.

Total items of parameter setup menu of the host system

System Set	
Languages	En
Unit	°C
Password	***
Keypad Tone	ON
▼ LCD Contrast	44

- Languages: Language displayed on the system menu.
- Unit: Temperature unit displayed on the system.
- Password: The authorization password to enter the system parameters interface.
- Keypad Tone: The switch to turn on and off the key operation tone.
- LCD Contrast: Contrast ratio adjustment displayed on the screen.

System setup	
▲ Mode	Nor
Net Address	1
Factory Default	ON
Exit	

- Mode: Used to define the Host communication.
- Net Address: Local communication address defined during networking operation.
- Factory Default: Resume the Host to the factory settings.
- Exit: Press to return to the main interface.

Host system setup parameters

Languages

System Set > Languages

System Set	
Languages	En
Unit	°C
Password	***
Keypad Tone	ON
▼ LCD Contrast	44

Used to set the system Language:

EN: English.

CN: Chinese.

The factory default is: English.

Unit

System Set > Unit

System Set	
Languages	En
Unit	°C
Password	***
Keypad Tone	ON
▼ LCD Contrast	44

Used to set the system temperature unit:

°C : Celsius.

°F : Fahrenheit.

The factory default is: °C .

System Set	
Languages	En
Unit	°C
Password	***
Keypad Tone	ON
▼ LCD Contrast	44

1. Used to lock the system and protect set parameters of the system from being changed by unauthorized person.
2. Coordinate with the fixed temperature of parameter setup of the handle channel, lock the temperature of the whole equipment and control the welding process. The factory default is: OFF.

System Lock-in

System Set > SystemLock-in

Set PIN code	Locked
	PIN Code : 000

Under the password setup state, enter a three-digit password, display the prompt locked by the system and shut down the prompt window 3s later. Press Enter to resume password setup.

System unlock

System Set > System unlock

Set PIN code	Message
	PIN code Error

Enter the correct password, the system is unlocked and the password is cancelled;
Enter the incorrect password, wrong password will be reminded.

Keypad Tone

System Set > Keypad Tone

System Set	
Languages	En
Unit	°C
Password	***
Keypad Tone	ON
▼ LCD Contrast	44

Used to open or close the prompt tone for key operation:
Open (ON): prompt tone is given for key operation.
Close (OFF): prompt tone is not given for key operation.
The factory default is: ON.

LCD Contrast

System Set > LCD Contrast

System Set	
Languages	En
Unit	°C
Password	***
Keypad Tone	ON
▼ LCD Contrast	44

Used to set the contrast ratio of the display screen:
10: minimum contrast ratio.
100: maximum contrast ratio.
The factory default is: 44.

System Set	
▲ Unit	°C
Password	* * *
Keypad Tone	ON
LCD Contrast	44
▼ Mode	Nor

Used to set the product communication mode:

Normal: close the communication function.

Host: used for function extension.

Slave: used for function extension.

The factory default is: normal.

System Set	
▲ Password	* * *
Keypad Tone	ON
LCD Contrast	44
Mode	Nor
▼ Net Address	1

Used for communication among many machines and can

be directed to 255 devices at most:

Adjustment range: 1-255 (used for function extension).

The factory default is: 1.

System Set	
▲ Keypad Tone	ON
LCD Contrast	44
Mode	Nor
Net Address	1
▼ Factory Default	

Used to restore system parameters and channel parameters to factory default.

After the factory default is restored through click confirmation, all system parameters and channel parameters will be restored to factory default.

Note: it is intended for parameters corresponding to the handles connected. The handles that have not been connected to the host will not be restored to factory default.

System Set	
▲ LCD Contrast	44
Mode	Nor
Net Address	1
Factory Default	ON
Exit	

Reset the dialog box:
 Select the function using “▲” or “▼”
 and press Enter to execute this function.

Exit System Set > Exit

System Set	
▲ LCD Contrast	44
Mode	Nor
Net Address	1
Factory Default	
Exit	

Used to exit from parameter setup and return to the main interface.
 All parameters changed will be stored upon exit.

Press the key 1 in the system setup menu to enter parameter setup of channel;

Total items of parameter setup menu of the handle channel

Channel Set		GT-X150
Temp Offset	0	
Standby Temp	250	
Standby Delay	OFF	
Shutdown Delay	OFF	
Shortcut Temp1	250	

- Temp Offset: used to compensate for the temperature output error of the handle.
- Standby Temp: the temperature of the handle when the system enters standby mode.
- Standby Delay: open and close the standby mode.
- Shutdown Delay: open and close the dormancy mode.
- Shortcut Temp1: set temperature 1 for user’s quick call.

Channel Set		GT-X150
Shortcut Temp2	300	
Shortcut Temp3	400	
Fix Temp	OFF	
Temp UL	480	
Temp LL	250	

- Shortcut Temp2: set temperature 2 for user’s quick call.
- Shortcut Temp3: set temperature 3 for user’s quick call.
- Fix Temp: after this function is started, the output temperature stays at the set temperature value.
- Temp UL: the maximum temperature that can be set by the user in the main working interface.
- Temp LL: the minimum temperature that can be set by the user in the main working interface.

Parameter setup menu of the handle channel

Temp Offset

Channel Set > Temp Offset

Channel Set	GT-X150 
Temp Offset	0
Standby Temp	250
Standby Delay	OFF
Shutdown Delay	OFF
Shortcut Temp1	250

Used to compensate for the temperature output error of the soldering pencil.

Compensation range: -50 C ~+50 C, -90 F ~+90 F .

In case of a positive value, the handle temperature will increase to the set value.

In case of a negative value, the handle temperature will decrease to the set value.

The factory default is: 0.

Note: if the user discovers that the temperature is inaccurate when replacing the heating core or the handle, it can be corrected through parameter modification as follows:

1. Set the handle temperature to be corrected at a suitable value, e.g. 350 C /662 F .
2. After the temperature remains stable, test the actual temperature of the current handle heater tip using temperature tester, e.g. the actual temperature is 365 C /689 F .
3. The actual temperature is 15 C /27 F higher than the set temperature when a conclusion is drawn through analysis.
4. Set the temperature compensation value as -15 C or -27 F , that is, compensate for the output temperature error.

Standby Temp

Channel Set > Standby Temp

Channel Set	GT-X150 
Temp Offset	0
Standby Temp	250
Standby Delay	OFF
Shutdown Delay	OFF
Shortcut Temp1	250

The temperature value when the handle enters standby mode:
250 C /482 F : the minimum standby temperature.

300 C /572 F : the maximum standby temperature.

When the set actual operational temperature is less than the set standby temperature, the product will enter standby mode at the actual operational temperature.

The factory default is: 250 C .

Standby Delay

Channel Set > Standby Delay

Channel Set	GT-X150 
Temp Offset	0
Standby Temp	250
Standby Delay	OFF
Shutdown Delay	OFF
Shortcut Temp1	250

The delay time (unit: min) taken by the product to enter standby mode automatically when the User leaves the handle unused for a long time:

OFF: the product will not enter standby mode.

1-120: the product starts standby function and enters standby mode within the specified time.

When the set actual operational temperature is less than the set standby temperature, the product will enter standby mode at the actual operational temperature.

The factory default is: OFF.

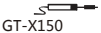
Channel Set 	
Temp Offset	0
Standby Temp	250
Standby Delay	OFF
Shutdown Delay	OFF
Shortcut Temp1	250

The delay time (unit: min) taken by the product to enter dormancy mode automatically when the User leaves the handle unused for a long time:

OFF: the product will not enter standby mode.

1-120: the product starts dormancy function and enters dormancy mode within the specified time.

The factory default is: OFF.

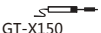
Channel Set 	
Temp Offset	0
Standby Temp	250
Standby Delay	OFF
Shutdown Delay	OFF
Shortcut Temp1	250

3 sets of data of set temperature for users' quick call: Limited to "maximum temperature" and "minimum temperature".

The factory default is:

Quick temperature 1: 250 C/482 F .

Quick temperature 2: 300 C/572 F .

Quick temperature 3: 400 C/752 F .

Channel Set		GT-X150 
▲ Shutdown Delay	OFF	
Shortcut Temp1	250	
Shortcut Temp2	300	
Shortcut Temp3	400	
▼ Fix Temp	OFF	

After this function is started, the handle temperature stays at the set temperature.

OFF: temperature lockout function is off.

250-480 °C/482-896 °F : temperature lockout is started, the handle works at the fixed temperature, and the user cannot change the set temperature in the main interface.

The fixed temperature is off when the temperature is lower than 250 °C/482 °F .

The factory default is: OFF.

Channel Set		GT-X150 
▲ Shortcut Temp1	250	
Shortcut Temp2	300	
Shortcut Temp3	400	
Fix Temp	OFF	
▼ Temp UL	450	

The maximum temperature that can be set by the user in the main working interface.

The set maximum temperature is 480 °C/896 °F .

The set minimum value of the “maximum temperature” should be no less than or equal to the “minimum temperature”.

The factory default is: 450 °C/842 °F .

Channel Set		GT-X150 
▲ Shortcut Temp2	300	
Shortcut Temp3	400	
Fix Temp	OFF	
Temp UL	450	
▼ Temp LL	250	

The minimum temperature that can be set by the user in the main working interface.

The set maximum temperature is 250 °C/482 °F .

The set maximum value of the “minimum temperature” should be no greater than or equal to the “maximum temperature”.

The factory default is: 250 °C/482 °F .



Channel Set		GT-X150 
▲ Shortcut Temp3	400	
Fix Temp	OFF	
Temp UL	450	
Temp LL	250	
Exit		

Used to exit from parameter setup and return to the main interface.

All parameters changed will be stored upon exit.

Connecting mode of the functional ground wire

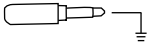
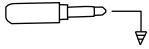
This product uses 3.5mm grounding plug, which is provided with the following four kinds of grounding modes:

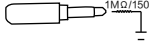
1		Hard grounding	Before the 3.5mm plug is inserted, the ground wire of the soldering tool handle is connected directly to the protective ground wire of the power line.
2		Equipotential connection	After the 3.5mm plug is inserted, the ground wire of the soldering tool handle is connected to the 3 pins of the 3.5mm plug.
3		Floating connection	When the 3.5mm plug is direct connected to the socket instead of being connected to the lead wire, the soldering tool handle is under floating state and unconnected with any ground.
4		Soft grounding	When the 3.5mm plug is connected to the ground via 1MΩ or 150KΩ resistor, electrostatic discharge loop is formed.

Schematic diagram of the soldering

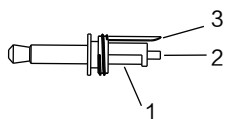

When the equipotential connection mode is chosen: the ground wire can achieve the related function via being connected to the pin 1, 2, 3.

Care and maintenance

Fault code or fault description	Likely causes of the faults
E-1: thermal fuse fault	<ol style="list-style-type: none"> 1. In case open circuit fault occurs to the heating core, replace it. 2. In case poor contact occurs to the heating core, unplug and then re-install it. 3. In case the internal connection cable inside the heating core & handle is broken or heating core connection contact piece is damaged, repair the broken lead wire or replace the soldering pencil.
E-2:sensor alarm	<ol style="list-style-type: none"> 1. In case the heating core is damaged, replace it. 2. In case open circuit occurs to the lead wire of the Sensor, check the lead wire of the soldering pencil.
E-3:zero-cross detection abnormal alarm	Send to the designated after-sales service outlet for maintenance.
E-4:abnormal temperature alarm	In case the heating object loses heat too fast, which cannot reach the set specified temperature even being heated for a long time. You need larger power soldering equipment.
E-5:over-current protection	<ol style="list-style-type: none"> 1. Short circuit occurs inside the heating core. 2. In case short circuit occurs to the internal lead wire of the soldering pencil, please replace the soldering pencil
E-6:abnormal system voltage	<ol style="list-style-type: none"> 1. In case the external power supply voltage is abnormal, please check if the input voltage of the product meets the requirements. 2. In case the host of the product is damaged, please send it to the designated after- sales outlet for maintenance.
E-8: abnormal soldering Tsui temperature	<ol style="list-style-type: none"> 1. In case the temperature sensor is abnormal, please replace the heating core. 2. In case the soldering head temperature is too high, please cool the iron head and then restart the equipment.
E-9: soldering Tsui handle status	<ol style="list-style-type: none"> 1. In case the handle is not compatible with this equipment, please replace it with the handle produced by the original factory. 2. In case the internal circuit is abnormal, please send the equipment to the designated after-sales outlet for maintenance.
Screen display fault:	<p>In case the problem occurs, you can try to adopt the following measures to solve it. If the problem still cannot be solved, please return the equipment to the original factory for inspection.</p> <ol style="list-style-type: none"> 1. Check if the socket switch is on. 2. Check if there is voltage on the socket. 3. Check if the plug with the power line is loose. 4. Check if the fuse is damaged (if so, please replace the fuse according to the specifications)
Inaccurate temperature:	<ol style="list-style-type: none"> 1. Use user temperature compensation function to correct the temperature. 2. Replace the heating core with one produced and sent by the original factory.
Mojibake:	<ol style="list-style-type: none"> 1. In case there is strong interference source from the outside environment, please change the application environment or evacuate from the interference area. 2. In case the internal circuit is abnormal, please send the equipment to the designated after-sales outlet for maintenance.

Product warranty

- This product is guaranteed for two years from the date of purchase (excluding consumables such as the heating core). If any quality problem is found within the guarantee period, we will response for the maintenance free of charge.
- For those products beyond the warranty period, we provide life-long maintenance services.
- For those product damaged due to users' improper application and unauthorized changes to the product parts, our company only provides limited warranty service.
- In case of a product fault, please send the faulty product to the designated maintenance shop for maintenance, and those service center and personnel unauthorized by the factory are prohibited from carrying out any maintenance on the product.

After-sales contact

Tel of After-sales Service Department: (+86) 755-26976387

Appendix

Exploded view of the equipment

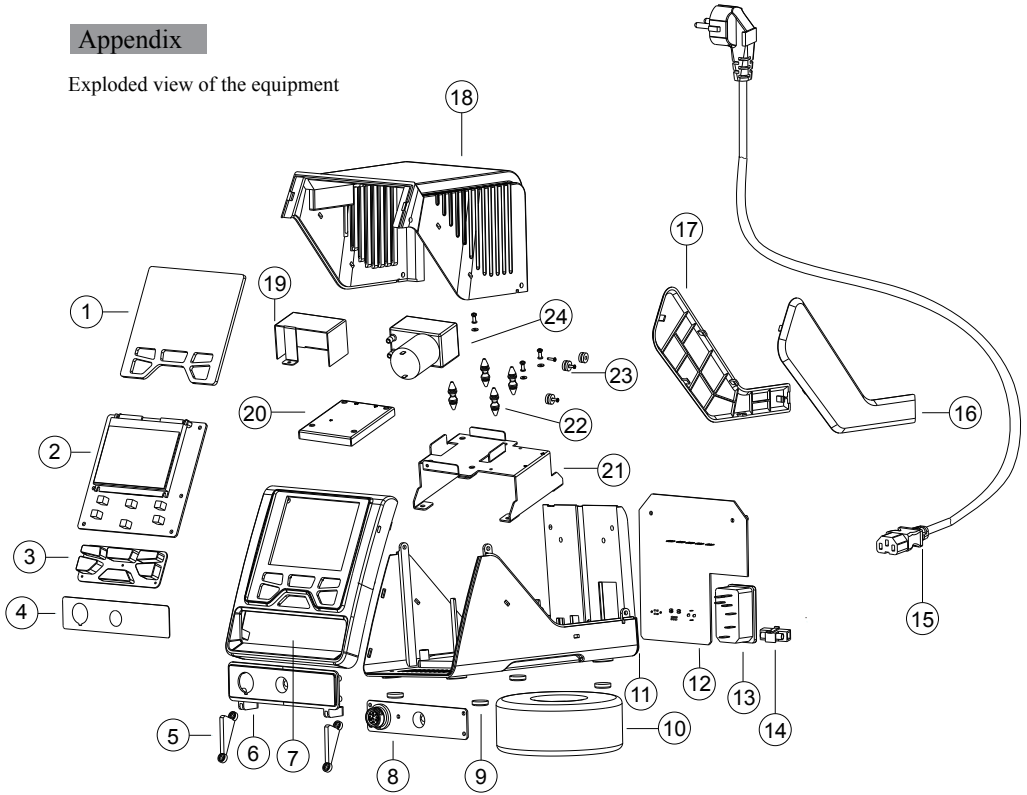

Serial No.	Material name	Serial No.	Material name	Serial No.	Material name
1	Display lens	9	Self-adhesive foot pad	17	Left decorative plate
2	Display board PCB	10	Transformer	18	Top shell
3	Silicone key	11	Bottom shell	19	Vacuum pump cover
4	Interface aluminum	12	Power board PCB	20	Sponge
5	Press plate	13	Public seat	21	Vacuum pump holder
6	Interface panel	14	Fuse	22	Shock pad
7	Panel	15	Power cable	23	Fan shock pad
8	Interface board PCB	16	Right decorative plate	24	Vacuum pump

Product warranty card

This product is guaranteed for two years from the date of purchase. If any quality problem is found within the guarantee period, we will response for the maintenance free of charge on presentation of this card and the receipt. We will repair and return the repaired equipment to the customer within 2 working days of the receipt date.

Note: This warranty card must be attached when this product is returned to the factory for maintenance, otherwise free maintenance will not be accepted. Thank you for your cooperation!

Product Certification

Product Model: _____ Product No.: _____

Inspector: _____ Ex-factory date: _____

Salesperson: _____ Sold Date: _____

SHENZHEN ATTEN TECHNOLOGY CO.,LTD.

- Soldering iron ● Soldering station ● Hot air rework station
- Multi-function maintenance system
- Regulated DC power supply ● Switching DC power supply
- Programmable power supply

SHENZHEN ATTEN TECHNOLOGY CO., LTD.

Add: Floor 8,Building 2,Senyang High-tech Park,7 West Road
High-tech Park, Guangming New district, Shenzhen 518132, China

Tel: +86-755-2697 6387

Fax: +86-755-8602 1337

Web: www.atten.com.cn(CN)

www.atten.com(EN)

Email: sales@atten.com.cn

Engineer's partner

All Copyright Reserved
MADE IN CHINA

CBN029726(A)