Operation Manual

TH6300 Series

Auto Range DC Power Supply

Tonghui Electronic Co.,Ltd.

www.tonghui.com.cn

Contents

| | |
|---|----|
| Chapter 1 Introduction..... | 1 |
| 1.1 Introduction to Instrument..... | 1 |
| 1.2 Working Condition..... | 1 |
| Chapter 2 Precautions for Usage | 2 |
| 2.1 Dimension and Weight..... | 2 |
| 2.2 Safety Requirements..... | 2 |
| 2.3 Electromagnetic Compatibility..... | 2 |
| Chapter 3 Introduction to Front and Rear Panels | 3 |
| 3.1 Introduction to Front Panel..... | 3 |
| 3.2 Introduction to Rear Panel..... | 4 |
| 3.3 Display Zone..... | 4 |
| 3.4 Introduction to Page Display | 5 |
| Chapter 4 Operation Instruction | 6 |
| 4.1 Output Display Page..... | 6 |
| 4.1.1 Voltage Setting | 6 |
| 4.1.2 Current Setting..... | 6 |
| 4.1.3 Time Setting | 6 |
| 4.1.4 Output..... | 6 |
| 4.2 Recall List..... | 7 |
| 4.2.1 Save Set | 7 |
| 4.2.2 Recall and Delete..... | 7 |
| 4.3 Trig File..... | 8 |
| 4.3.1 Voltage/Current/Time Setting | 8 |
| 4.3.2 Trig Number & Cycle Time Setting | 9 |
| 4.3.3 Save File & Trig Load..... | 10 |
| 4.4 System Menu Setting..... | 11 |
| 4.4.1 Range Setting..... | 11 |
| 4.4.2 Language Setting | 11 |
| 4.4.3 Key Voice Setting..... | 11 |

| | | |
|--|------------------------------------|----|
| 4.4.4 | P-Mem Setting..... | 11 |
| 4.4.5 | Trig Mode Setting..... | 12 |
| 4.4.6 | Sampling Mode Setting | 12 |
| 4.4.7 | OVP & OCP | 12 |
| 4.4.8 | Bus Mode..... | 12 |
| 4.4.9 | Baud Rate | 12 |
| 4.4.10 | GPIB Address | 13 |
| 4.4.11 | Date..... | 13 |
| Chapter 5 Correct Use of the Instrument..... | | 14 |
| Chapter 6 Interface and Communication..... | | 15 |
| 6.1 | Remote Control Interface | 15 |
| 6.1.1 | RS232 Interface | 15 |
| 6.1.1.1 | RS232 Interface Introduction | 15 |
| 6.1.1.2 | Communicate with Computer..... | 16 |
| 6.1.2 | GPIB Interface..... | 17 |
| 6.1.2.1 | GPIB Bus..... | 17 |
| 6.1.2.2 | GPIB Interface Function..... | 19 |
| 6.1.2.3 | GPIB Address..... | 19 |
| 6.1.3 | USBCDC | 19 |
| 6.1.3.1 | System Configuration..... | 19 |
| 6.1.3.2 | Install Driver..... | 19 |
| 6.2 | Command Instruction | 21 |
| 6.2.1 | Syntax Conventions..... | 21 |
| 6.2.2 | Command Reference | 22 |
| 6.2.2.1 | Supported GPIBCommon Command | 22 |
| 6.2.2.2 | SCPI Command | 22 |
| Chapter 7 Specification | | 29 |

Declaration

The descriptions contained in this manual may not cover all information about this instrument. Introductions to the improvements of the instrument in performance, function, internal structure, outer appearance, accessories, packing material, etc. are subject to change without notice. If you find any inconformity of this manual with our instruments, please contact us for further consultation by the address listed on the cover.

Chapter 1 Introduction

Thank you for your purchase and use of our products. This chapter will introduce the basic instrument performance.

1.1 Introduction to Instrument

TH6300 series is a single-channel programmable linear DC power supply with auto range. This series of instruments have powerful functions and superior performance. The use of LCD screen display makes the display clear and menu operation easy, which adapt to the needs of rapid operation on the production site and high precision and stability of high-precision laboratory. Also, being equipped with RS232 interface, USB interface and GPIB interface, they are convenient for the instrument used in remote operation of the computer.

Special features and benefits of the instrument are as follows:

- 480*272 pixels, 24-bit color, 4.3-inch color TFT LCD screen, used to set the test conditions and measurement results display
- Numeric keyboard operation
- High accuracy and high resolution
- Support shutdown data saving and starting up data loading
- Support voltage measurement function
- Support data saving and recalling
- Support list setting and output in steps
- Intelligent fan control to save energy and reduce noise
- Software control and testing through the computer
- Interface: RS232, USB, GPIB (option)

1.2 Working Condition

- **Power Connection**✂

Power supply: 220V (1±10%)

Power supply frequencies: 50Hz/60Hz (1±5%)

Power range: <50VA

- **Environment Temperature and humidity**

Normal working temperature: 0°C to 40°C Humidity: < 90%RH

Reference working temperature: 20°C ±8°C Humidity: < 80%RH

Transport working temperature: 0°C ~55°C Humidity: ≤93%RH

- **Warm-up**

For accurate measurement, the warm-up time should not be less than 20 minutes.

Chapter 2 Precautions for Usage

- Please do not use the tester in dusty, vibrative, direct sunlight and corrosive gases and other adverse environments.
- When the instrument is not used for a long time, please put it in the original box or similar box and stored in a ventilated room with temperature of 5°C~40°C and relative humidity less than 85% RH. Do not store the tester in a corrosive atmosphere containing harmful impurities and should avoid direct sunlight.
- The instrument has been carefully designed to reduce clutter due to AC power input. However, it should still be used under low noise conditions. If that is inevitable, please install the power filter.
- There is cooling fan on the rear panel and cooling vents in the left and right case to avoid influencing the accuracy due to internal temperature rise. Please make sure the instrument is in good ventilation.
- Do not switch the instrument frequently to avoid loss of stored data.

2.1 Dimension and Weight

- **Dimension (W*H*D):** 218mm*88.8mm*412mm
- **Weight:** 8.1kg

2.2 Safety Requirements

This tester is a Class I safe equipment.

.2.1 Insulation resistance

In the reference working conditions, the insulation resistance between the power terminals and the shell is not less than 50MΩ.

In hot and humid transport conditions, the insulation resistance between the power terminals and the shell is not less than 2MΩ.

.2.2 Dielectric strength

In the reference working conditions, the power terminal and the shell can withstand for one minute with no breakdown and flashover phenomenon of 1.5kV rated voltage and 50Hz frequency of AC voltage.

.2.3 Leakage current

The leakage current is not greater than 3.5mA.

2.3 Electromagnetic Compatibility

2.3.1 Power Transient Sensitivity, refer to requirements of GB6833.4.

2.3.2 Conducted Susceptibility, refer to requirements of GB6833.6.

2.3.3 Radiated interference, refer to requirements of GB6833.10.

Chapter 3 Introduction to Front and Rear Panels

3.1 Introduction to Front Panel

Figure 3-1 shows the front panel of TH6302.

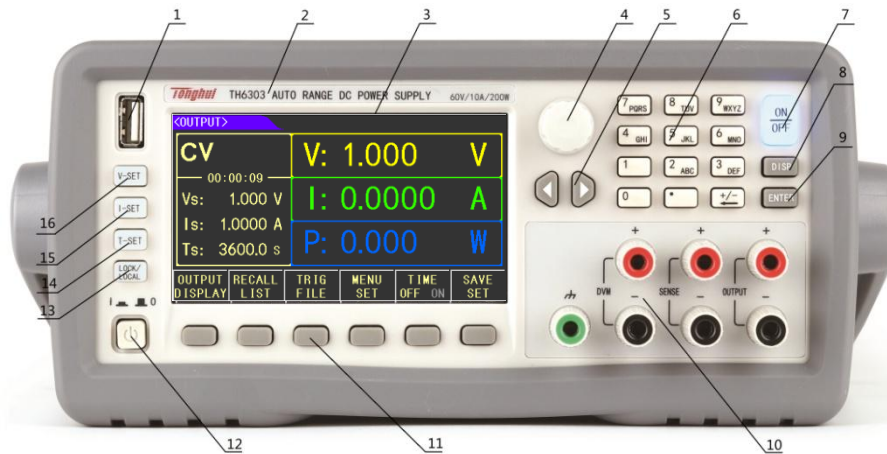

Figure 3-1

| | | |
|----|----------------------|--|
| 1 | USB Interface | HOST interface of USB |
| 2 | Trademark and Model | Show instrument trademark, model, and power supply ranges |
| 3 | LCD Screen | 480*272 dot-matrix, used for measurement setup, status, and result display etc. |
| 4 | Knob | Used for adjusting parameters, and moving arrow/cursor |
| 5 | Universal Arrow Keys | Left and right arrow keys used for moving cursor |
| 6 | Numeric Keyboard | Used for entering numbers |
| 7 | Output ON/OFF | Turn on/off output |
| 8 | DISP | Enter into setup and testing interface |
| 9 | ENTER | Terminate and store input data. |
| 10 | OUTPUT/SENSE | [+, -] used for power output [+S,-S] used for four-terminal sampling |
| 11 | SOFTKEYs | Those six buttons are screen-labeled function keys located alongside the screen. They can invoke a function described by the text at that moment shown adjacent to the button on the display |
| 12 | POWER | Power switch |
| 13 | LOCK/LOCAL | A key used for locking the keyboard while switching into remote control mode. Since the backlight of the button is on, the keyboard will be locked so that the instrument can only be remote controlled. |
| 14 | T-SET | Time setting |

| | | |
|----|-------|-----------------|
| 15 | I-SET | Current setting |
| 16 | V-SET | Voltage setting |

Figure 3-1

3.2 Introduction to Rear Panel

Figure 3-2 shows the rear panel of TH6302.

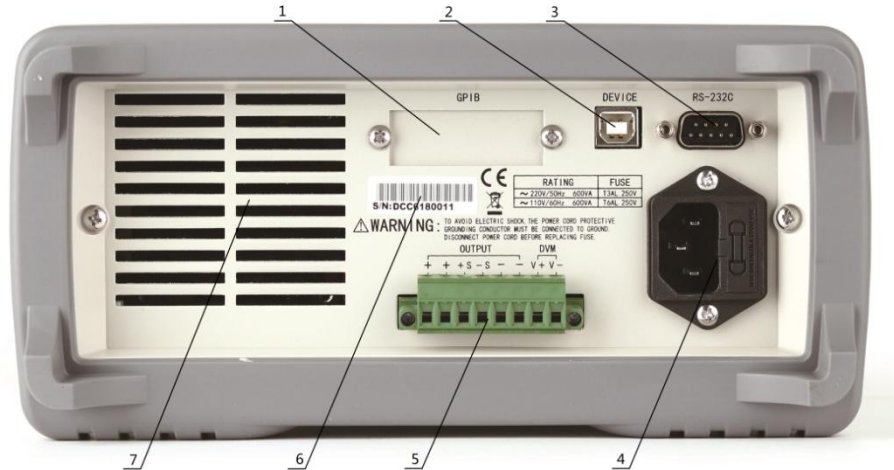

Figure 3-2 Rear Panel

| | | |
|---|------------------------|---|
| 1 | GPIB Interface | It realizes parallel communication of the instrument with PC, and create GPIB testing system. |
| 2 | USB Interface | Computer control can be realized through the USB DEVICE interface |
| 3 | RS232 Serial Interface | It realizes serial communication of the instrument with PC |
| 4 | Three-pin Plug | Used for connecting 220V/50HZ AC power |
| 5 | Measuring Terminal | It has the same function as the front panel output and sampling end. |
| 6 | Nameplate | It shows production date, model, batch number, and manufacturer. |
| 7 | Fan | Temperature control |

Table 3-2

3.3 Display Zone

The display zone is shown below in figure 3-3.

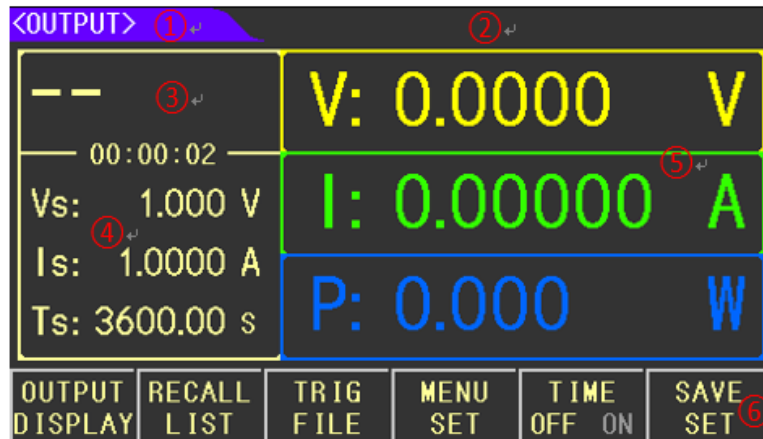

Figure 3-3 Display zone

- (1) Page Display Zone
This zone shows the current page name.
- (2) Error Message Zone
This zone displays the corresponding information when the instrument is running or operating incorrectly.
- (3) Current Output Mode Display Zone
This zone displays the current output mode, CV, CC and die out time.
- (4) Quick Set-up Zone
This zone works for quick set-up of voltage, current and time.
- (5) Output Display Zone
This zone displays the real-time output voltage, current and power.
- (6) Software Menu Zone
The content is flexible, display the function matched with the adjacent softkey.

3.4 Introduction to Page Display

- Output Display
This page is the boot default page for quickly setting output values and displaying measurements.
- Recall List
This page is used to store voltage and current setting values. When needed, the corresponding value can be recalled from this page to replace the current setting value.
- Trig File
This page is used to control the output trigger, set trigger sequence number and number of cycles of the corresponding file.
- File1~File10
This page is used to set the voltage value, current value and lasting time of the corresponding trigger file.
- Trig Output DISP
This page is used to display the output of the instrument in the triggered state.
- Menu Set
This page is used to set how the instrument works.

Chapter 4 Operation Instruction

4.1 Output Display Page

Press **DISP** button on the front panel, or use the output display option from the software menu to enter < output display > page. Use **V-set**, **I-set**, **T-set** button on the front panel can also quickly switch to this page (Figure 4-1).

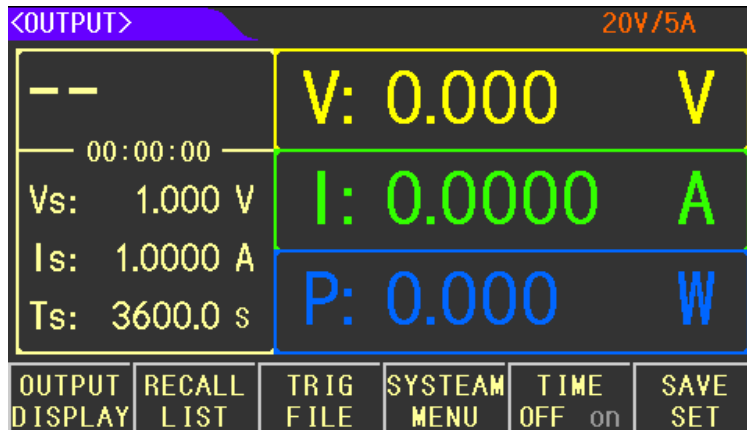

Figure 4-1

4.1.1 Voltage Setting

Step 1: Press **V-SET** button from the front panel to start voltage setting.

Step 2: Move the blinking digit to the desired position using **Left/Right** arrow button and adjust the blinking digit value with the **knob**. You can also use the **number buttons** to input the specific value and finish with **Enter** key.

4.1.2 Current Setting

Step 1: Press **I-SET** button from the front panel to start current setting.

Step 2: Move the blinking digit to the desired position using **Left/Right** arrow button and adjust the blinking digit value with the **knob**. You can also use the **number buttons** to input the specific value and finish with **Enter** key.

4.1.3 Time Setting

Step 1: Press **T-SET** button from the front panel to start time setting.

Step 2: Move the blinking digit to the desired position using **Left/Right** arrow button and adjust the blinking digit value with the **knob**. You can also use the **number buttons** to input the specific value and finish with **Enter** key.

4.1.4 Output

While voltage, current, and time setting were finished, pressing **ON/OFF** button to start output. Since output is enabled, the backlight of the button will be turned on, the measured real output value and output mode will be displayed on the screen.

If a timer is needed, turn on the time function (it cannot be enabled in TRIG mode)
Time function is displayed below in figure 4-2.



Figure 4-2

Press the time option in the software bar to turn **ON/OFF** the time function.

When output is enabled, if time function is off, timer will count up, if time function is on, timer will count down. The timer will be displayed in the screen. When timing is completed, the output will be turned off automatically.

4.2 Recall List

Press RECALL LIST from the software bar to enter Recall List page (shown in figure 4-3). This page is used to save voltage value, current value, overvoltage value, and overcurrent value. Stored values can be recalled from this page when needed.

| <RECALL> | | | | 20V/5A | |
|----------|-------|-------|-------|--------|--|
| No. | VOLT | CURR | OVP | OCP | |
| 001 | ----- | ----- | ----- | ----- | |
| 002 | ----- | ----- | ----- | ----- | |
| 003 | ----- | ----- | ----- | ----- | |
| 004 | ----- | ----- | ----- | ----- | |
| 005 | ----- | ----- | ----- | ----- | |
| 006 | ----- | ----- | ----- | ----- | |
| 007 | ----- | ----- | ----- | ----- | |
| 008 | ----- | ----- | ----- | ----- | |
| 009 | ----- | ----- | ----- | ----- | |
| 010 | ----- | ----- | ----- | ----- | |

| | | | | | |
|---------|--------|------|--------|--------|------|
| OUTPUT | RECALL | TRIG | SYSTEM | TIME | SAVE |
| DISPLAY | LIST | FILE | MENU | off ON | SET |

Figure 4-3

4.2.1 Save Set

SAVE SET function is shown in figure 4-4



Figure 4-4

While voltage and current values were set in the OUTPUT DISPLAY page, pressing SAVE SET in the software bar, those values will be saved in the recall list. Data will be written in the list in order, and a total of 100 sets of data can be saved.

4.2.2 Recall and Delete

RECALL LIST consists of 10 pages, and each page can save up to 10 sets of data. You can use **arrow buttons** or **Page Up/Down** options in the software bar to review all the stored data.

When a group of data needs to be recalled, you just need to go to the page where the data is saved, rotate the **knob** to make the arrow indicator point to the group of data, and select RECALL, the group of data will overwrite the setting value. To delete a group of data, select the delete option.

Note that the data in recall list is stored temporarily, and the data will be cleared after the machine is restarted. If you want to load the saved data after starting up, you need to set up the P-Mem function in MENU SETTING page. For the detailed instruction, please refer to 4.4.4.

4.3 Trig File

Press TRIG FILE in the software bar to enter TRIGGER page (shown in figure 4-5). This page is used for setting output steps. It allows users to set different steps of output in order to generate desired signals.

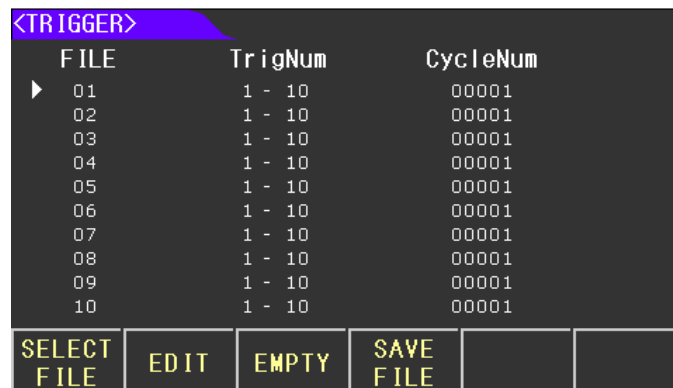

| FILE | TrigNum | CycleNum |
|------|---------|----------|
| ▶ 01 | 1 - 10 | 00001 |
| 02 | 1 - 10 | 00001 |
| 03 | 1 - 10 | 00001 |
| 04 | 1 - 10 | 00001 |
| 05 | 1 - 10 | 00001 |
| 06 | 1 - 10 | 00001 |
| 07 | 1 - 10 | 00001 |
| 08 | 1 - 10 | 00001 |
| 09 | 1 - 10 | 00001 |
| 10 | 1 - 10 | 00001 |

| | | | | | |
|-------------|------|-------|-----------|--|--|
| SELECT FILE | EDIT | EMPTY | SAVE FILE | | |
|-------------|------|-------|-----------|--|--|

Figure 4-5

This page includes 10 files, and each file can store up to 100 sets of data. Each set of data includes voltage, current, and time. Each file can be triggered with different cycles times and different number of steps.

4.3.1 Voltage/Current/Time Setting

Step 1: Rotate the **knob** to move the arrow pointing to the file that you want to edit.

Step 2: Press EDIT to go into the page.

Step 3: Set the Voltage, Current, and Time (show in figure 4-6). There are two methods to do the setting which are listed below:

| No. | VOLT | CURR | TIME |
|-----|-------|--------|-------|
| 001 | 2.000 | 1.0000 | 1.0 |
| 002 | ----- | ----- | ----- |
| 003 | ----- | ----- | ----- |
| 004 | ----- | ----- | ----- |
| 005 | ----- | ----- | ----- |
| 006 | ----- | ----- | ----- |
| 007 | ----- | ----- | ----- |
| 008 | ----- | ----- | ----- |
| 009 | ----- | ----- | ----- |
| 010 | ----- | ----- | ----- |

VOLT SET CURR SET TIME SET UP PAGE DOWN PAGE EXIT

Figure 4-6

| No. | VOLT | CURR | TIME |
|-----|-------|-------|-------|
| 001 | 2 | ----- | ----- |
| 002 | ----- | ----- | ----- |
| 003 | ----- | ----- | ----- |
| 004 | ----- | ----- | ----- |
| 005 | ----- | ----- | ----- |
| 006 | ----- | ----- | ----- |
| 007 | ----- | ----- | ----- |
| 008 | ----- | ----- | ----- |
| 009 | ----- | ----- | ----- |
| 010 | ----- | ----- | ----- |

mV V Esc

Figure 4-7

Method1: Set parameters one by one

Rotate the knob to move the arrow pointing to the desired data set index, then use the **Left/Right** button to move the cursor to the desired place and set the parameters with **number buttons** (show in figure 4-7).

Method2: Set parameters in series

After entering into the File page, the software bar will display voltage set, current set, and time set (show in Figure 4-8). Make use of each option to do the corresponding setting (show in figure 4-9).

| No. | VOLT | CURR | TIME |
|-----|-------|--------|-------|
| 001 | 2.000 | 1.0000 | 1.0 |
| 002 | ----- | ----- | ----- |
| 003 | ----- | ----- | ----- |
| 004 | ----- | ----- | ----- |
| 005 | ----- | ----- | ----- |
| 006 | ----- | ----- | ----- |
| 007 | ----- | ----- | ----- |
| 008 | ----- | ----- | ----- |
| 009 | ----- | ----- | ----- |
| 010 | ----- | ----- | ----- |

VOLT SET CURR SET TIME SET UP PAGE DOWN PAGE EXIT

Figure 4-8

| No. | VOLT | CURR | TIME |
|-----|-------|--------|-------|
| 001 | 2.000 | 1.0000 | 1.0 |
| 002 | ----- | ----- | ----- |
| 003 | ----- | ----- | ----- |
| 004 | ----- | ----- | ----- |
| 005 | ----- | ----- | ----- |

Bgn Num : 001 Step Count: 10
 Bgn Value : 1.000 V End Value : 10.000 V
 Step Value: 1.000 V

CREAT RETURN

Figure 4-9

While data setting were completed, press CREATE button, the data will be written in the table.

Description of the parameters in Figure 4-9

Bgn Num: Start index of the data series

Step Count: Total amount of data in the data series

Bgn Value: Value of the first data in the data series

End Value: Value of the last data in the data series

Step Value: The value of increment or decrement between each two adjacent data

4.3.2 Trig Number & Cycle Time Setting

The previous sections taught us how to set parameters, but while triggering those data, we need to go back to TRIGGER page.

As you are in the FILE page now, press EXIT to go back to TRIGGER page (show in figure 4-10).

| <TRIGGER> | | |
|-----------|---------|----------|
| FILE | TrigNum | CycleNum |
| 01 | 1 - 10 | 00001 |
| 02 | 1 - 10 | 00001 |
| 03 | 1 - 10 | 00001 |
| 04 | 1 - 10 | 00001 |
| 05 | 1 - 10 | 00001 |
| 06 | 1 - 10 | 00001 |
| 07 | 1 - 10 | 00001 |
| 08 | 1 - 10 | 00001 |
| 09 | 1 - 10 | 00001 |
| 10 | 1 - 10 | 00001 |

| | | | | | |
|---------|--------|--------|---------|--|--|
| DECR -- | DECR - | INCR + | INCR ++ | | |
|---------|--------|--------|---------|--|--|

Figure 4-10

Using the **knob** and the **Left/Right buttons** to move the cursor to the desired place and set the data with **number keys**.

4.3.3 Save File & Trig Load

In order to save the data in the flash so that the power supply can reload the data next time, users need to do the following operations (Figure 4-5).

Step 1: Move the arrow with the **knob** pointing to the desired file index.

Step 2: Press SAVE FILE button

Remind: To enable this function you need to ensure P-men set to User Data in Menu setting (please refer to 4.4.4).

Make sure the arrow is still pointing to the file, press TRIG LOAD button to trig the file, press TRIG OFF to quit the function (figure 4-11).

While TRIG LOAD is enabled, the selected file index will change to red color (Figure 4-12). Then press **ON/OFF** button to enable output. You can use TRIP DISP function to review the overall output data (Figure 4-13).



Figure 4-11

| <TRIGGER> | | | 20V/5A |
|-----------|---------|----------|--------|
| FILE | TrigNum | CycleNum | |
| 01 | 1 - 10 | 00001 | |
| 02 | 1 - 10 | 00001 | |
| 03 | 1 - 10 | 00001 | |
| 04 | 1 - 10 | 00001 | |
| 05 | 1 - 10 | 00001 | |
| 06 | 1 - 10 | 00001 | |
| 07 | 1 - 10 | 00001 | |
| 08 | 1 - 10 | 00001 | |
| 09 | 1 - 10 | 00001 | |
| 10 | 1 - 10 | 00001 | |

| | | | | | |
|----------|-----------|--|--|--|--|
| TRIG OFF | TRIG DISP | | | | |
|----------|-----------|--|--|--|--|

| <TRIG OUTPUT> | | | | Fi: 01 |
|---------------|------|------|------|-------------|
| No. | VOLT | CURR | TIME | Num: 1 - 10 |
| 001 | | | | Cyc: 1/1 |
| 002 | | | | |
| 003 | | | | |
| 004 | | | | |
| 005 | | | | |
| 006 | | | | |
| 007 | | | | |
| 008 | | | | |
| 009 | | | | |
| 010 | | | | |

| | | | | | |
|---------|-----------|------|--|--|--|
| UP PAGE | DOWN PAGE | EXIT | | | |
|---------|-----------|------|--|--|--|

Figure 4-13

4.4 System Menu Setting

The Menu page is mainly used for system setting (figure 4-14).



Figure 4-14

Step 1: Press **DISP** button to go to OUTPUT page.

Step 2: Press SYSTEM MENU in the software bar to enter into MENU setting page.

Step 3: Move the cursor to the desired place with the **knob** or **Left/Right** buttons, and use the software bar to do the corresponding setting.

4.4.1 DVM Setting

Switch on/off voltage measurement function as required.

4.4.2 Language Setting

Th6300 series power supply provides two display language.

- Simplified Chinese
- English

4.4.3 Key Voice Setting

Based on users' needs, Key voice can be turned on/off.

- On
- Off

4.4.4 P-Mem Setting

This function is used to set whether to load the saved parameters/settings or restore to the default setting after restart.

Default: Boot in factory Setting and does not load any parameters (data won't be stored after restart).

User Data: While users had already set some parameters or did some system settings, and need to restore the settings/data, this option should be selected.

Restore Default: Restore all settings to factory defaults.

4.4.5 Trig Mode Setting

- MAN: In this mode, the trigger function can be realized through the instrument keys
- BUS: In this mode, the instrument keys cannot achieve the trigger function, which can only be achieved by the upper computer instruction

4.4.6 Sampling Mode Setting

When the current flowing through the load, the voltage drop will be generated on the connection line from the power supply to the load. Therefore, the actual voltage applied on the load is slightly lower than what we set on the instrument. In order to ensure the measurement accuracy, the instrument has been designed to have the function of four-terminal sampling which helps compensated the loss of the voltage drop.

- Two ports sampling: Measure the voltage and current between [+ , -].
- Four ports sampling: Make use of [S+, S-] to ensure the measurement accuracy.

4.4.7 OVP & OCP

Overvoltage protection (OVP) and Overcurrent protection (OCP) guards the load against output voltage/current reaching values greater than the programmed protection level. When the output value exceeds the protection level, the output of the instrument will be cut off to ensure the safety of the instrument and the load

- OVP: Overvoltage protection
- OCP: Overcurrent protection

4.4.8 Bus Mode

TH6200 series power supply provides four communication modes. Select the required communication option and connect the communication port from the rear panel to realize the corresponding communication function.

- RS232
- GPIB
- USB-CDC
- USB-TMC

4.4.9 Baud Rate

- 4800

- 9600
- 19200
- 38400
- 57600
- 115.2k

4.4.10 GPIB Address

The GPIB connector on the rear panel connects the power supply to the computer and other GPIB devices. Each device on the GPIB interface must have a unique address. You can set the power supply's address to any value between 0 and 32.

4.4.11 Date

Th6200 series power supply has a built-in RTC clock, which can display the real time. Move the cursor to Date option and press SET button on the software bar to do the setting. Refer to the actual time to set year, month, day, hour, minute and second.

Chapter 5 Correct Use of the Instrument

Step 1: Connect the instrument to the electricity supply.

Step 2: Press the power button.

Step 3: Warm-up the device for 20min.

Step 4: According to actual needs, select connection line, and connect the load to [+ , -] ports of the instrument. If four ports sampling is needed, two additional connection lines are required, and connect the load to [S+ , S-] ports of the instrument.

Step 5: Set operating mode and parameters.

Step 6: Press ON/OFF to output power.

Chapter 6 Interface and Communication

TH6300 series power supply provides RS232C serial interface, GPIB parallel interface and USB interface for data transmission and remote control, but the three interfaces cannot be used at the same time. They share the same program-controlled commands but use different hardware configurations and communication protocols. This chapter describes the use of the interface, and the interface command will be introduced in chapter 6.2.

6.1 Remote Control Interface

6.1.1 RS232 Interface

Th6300 series power supply provides RS232 interface which can be used for communication with the computer. It supports robust program control commands. Through the RS232 interface, the computer is able to operate almost all the functions of instrument.

6.1.1.1 RS232 Interface Introduction

RS-232 standard, also called as asynchronous serial communication standard, has already been widely used for data communication between computers, computer and external equipment. RS is the English abbreviation of Recommended Standard; 232, the standard number. This standard is issued by EIA in 1969, which rules to send one bit in a data line every time.

Most serial interfaces are not strictly based on RS-232 standard; Use a 25-pin connector (IMB AT uses a 9-pin connector) on each port. The most commonly used RS-232 signals are shown in the table 6-1:

| Signal | Code | 25 Pin Connector Pin number | 9 Pin Connector Pin number |
|----------------------|------|--------------------------------|-------------------------------|
| Request To Send | RTS | 4 | 7 |
| Clear To Send | CTS | 5 | 8 |
| Data Set Ready | DSR | 6 | 6 |
| Data Carrier Detect | DCD | 8 | 1 |
| Data Terminal Ready | DTR | 20 | 4 |
| Transmitted the data | TXD | 2 | 3 |
| Receive the data | RXD | 3 | 2 |
| Grounding | GND | 7 | 5 |

Table 6-1

Like most serial ports in the world, the serial interface of this instrument is not strictly based on the RS-232 standard, but only provides a smallest subset, the signals are listed in table 6-2

| Function | Code | Pin Connector Pin Number |
|------------------|------|--------------------------|
| Transmitted Data | TXD | 3 |
| Received Data | RXD | 2 |

| | | |
|----------------------|-----|---|
| Signal Ground Common | GND | 5 |
|----------------------|-----|---|

Table 6-2

This is the easiest and cheapest way to use serial port communication.

Note: The serial port pin definition of this instrument is the same as that of the standard 9-pin RS232C connector.

The RS232C connector of the instrument is a 9-pin type DB socket, and the pin sequence is shown in figure 6-1:

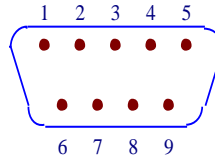

Figure 6-1

A standard DB type 9-pin plug can be connected to it directly.

Caution: To avoid electrical shock, turn off the power supply when plugging or unplugging the connector; do not short-circuit the output terminals or short-circuit the chassis to avoid damage to the device.

6.1.1.2 Communicate with Computer

Connection between TH6300 series power supply and a computer shown as figure 6-2:

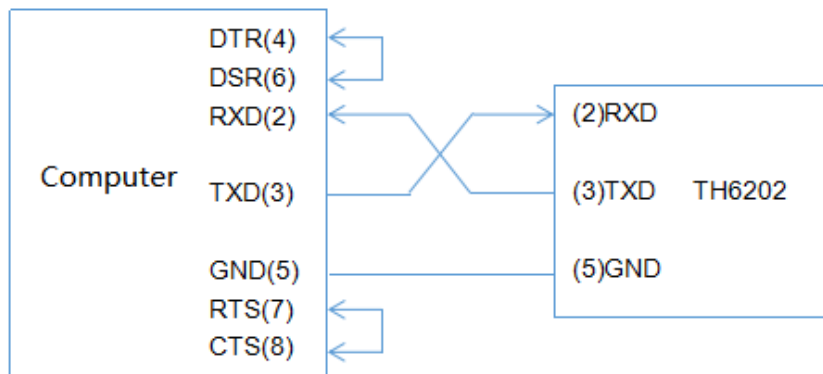

Figure 6-2

As can be seen from the above figure, the pin definition of this instrument is the same as that of the 9-pin connector serial interface pin used by the IMB AT compatible machine. Users can use the double-core shielded cable to self-make a three-wire connection cable (the length should be less than 1.5m), or purchase the serial interface cable between the computer and the instrument from our company or purchase the standard DB type 9-pin plug.

When making the connection cable, pin 4 and 6, pin 7 and 8 should be shorted respectively at the computer connector.

When use RS232 interface to communicate with the computer, you need to set the BUS MODE to

RS232 from the system menu.

RS232 parameters are listed in table 6-3

| | |
|-------------------|---|
| Transmission Mode | Full duplex asynchronous communication with start and stop bits |
| Baud Rate | 9600 bps |
| Start bit | 8 BIT |
| Stop bit | 1 BIT |
| Parity bit | No |
| Terminator | NL (newline, ASCII code 10) |
| Communication | Software |
| Connector | DB9 |

Table 6-3

6.1.2 GPIB Interface

6.1.2.1 GPIB Bus

IEEE488 (GPIB) is an international bus interface standard used on intelligent instruments. IEEE is the English abbreviation of Institute of Electrical and Electronics Engineers, and 488 is the standard number. Through this interface, TH6300 series power supply is able to communicate with PC or other intelligent equipment and can make up automatic test system with the other test instruments. Multiple test instruments can be connected simultaneously on the same bus. This instrument adopts IEEE488.2 standard, and the GPIB interface is a customer option. Command control system is open to users so that users can make use of the PC operation interface provided by the instrument or take measurements by the command control system. The command control system supports most functions of the instrument, that is to say, users can execute almost all operations on PC. Thus remote control of the instrument is realized.

The following points should be noted when using the GPIB system

1. The total length of cable in one bus system must be less than or equal to two meters times the number of devices connected on the bus (the GPIB controller counts as one device) and the total length of cable must not exceed 20 meters.
2. A maximum of 15 devices can be connected on one bus system.
3. There are no restrictions on how the cables are connected together. However, it is recommended that no more than four piggyback connectors be stacked together on any device.

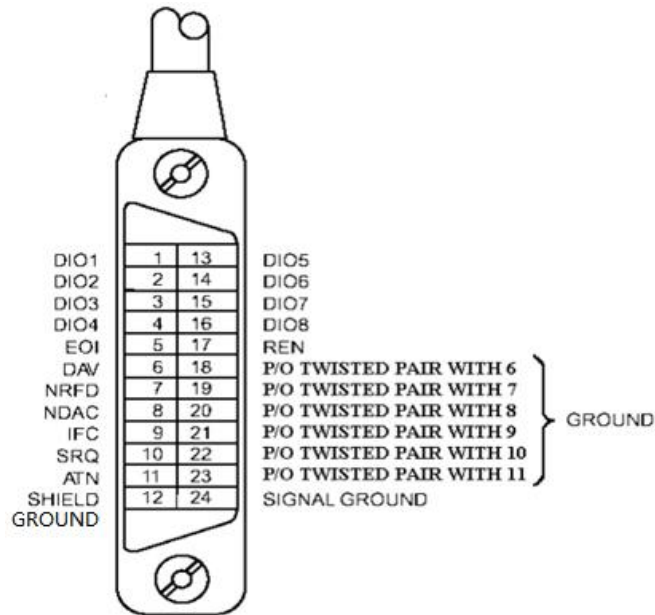

GPIB Cable Connection Method 1:

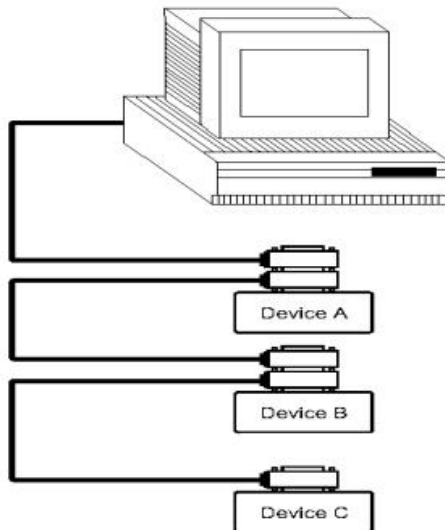

GPIB Cable Connection Method 2:

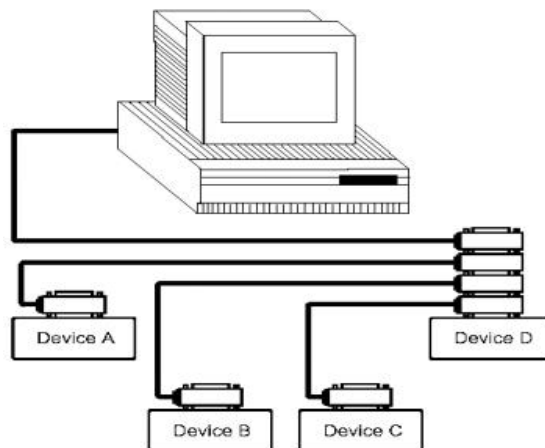

6.1.2.2 GPIB Interface Function

This instrument provides most general functions of GPIB, see in table 6-4:

| Code name | Function |
|-----------|--|
| SH1 | Support all data source contact function |
| AH1 | Support all receiver contact function |
| T5 | Basic talker function, talk only function, talk is cancelled when in MLA, serial point name is not supported |
| L4 | Basic Listener function, the MTA is cancelled, no listening function |
| RL1 | Remote control / local function |
| DC1 | Device clear function |
| DT1 | Device trigger function |
| C0 | No controller function |
| E1 | Open collector drive |

Table 6-4

6.1.2.3 GPIB Address

The instrument's GPIB is addressed in a single address mode with no secondary address. Users can set 1-32 as their own GPIB address, the default GPIB address of the TH6300 is 8.

6.1.3 USBCDC

By selecting the bus mode "USBCDC", the USB interface can be configured as a virtual serial port (VCom).

6.1.3.1 System Configuration

Connect the USB interface on the rear panel of TH6300 with the USB interface on the host with USB cable.

6.1.3.2 Install Driver

Connecting the USB interface on the rear panel of TH6300 with the USB interface on the host computer, then open the computer device manager, as shown in figure 6-6

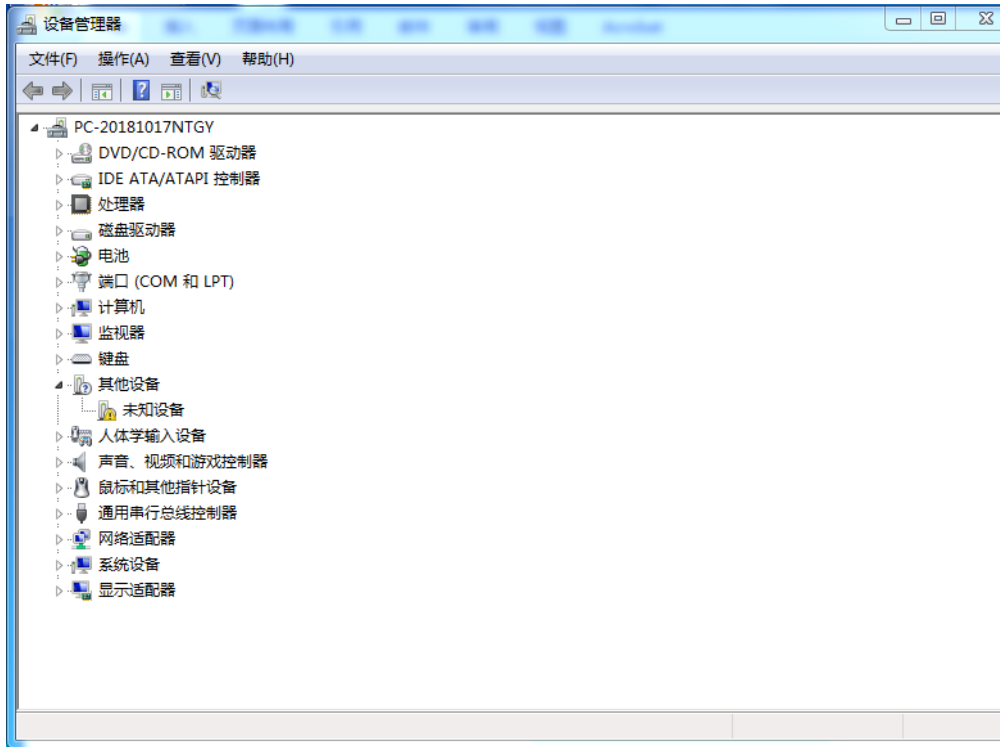

Figure 6-6

Right-click "unknown device" and select "update driver software", and the dialog box will pop up as shown in figure 6-7

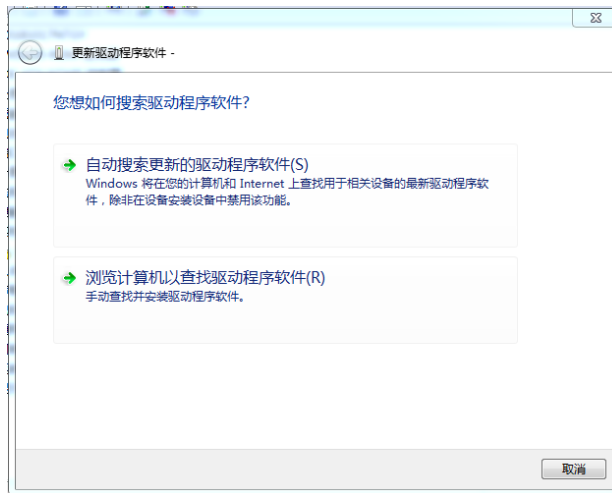

Figure 6-7

Click "browse the computer to find driver software", and the dialog box appears as shown in figure 6-8

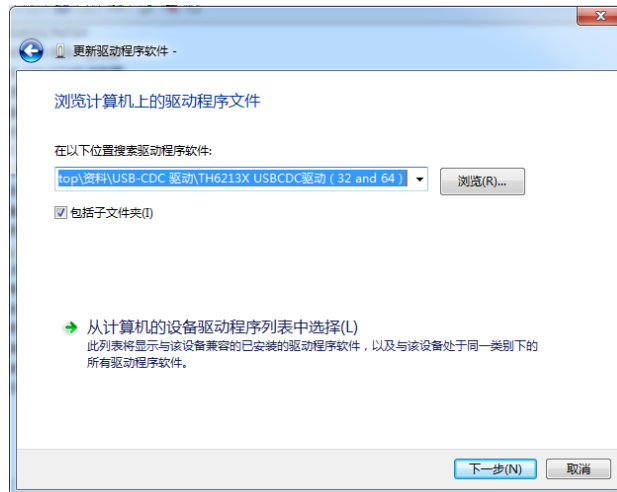

Figure 6-8

Select the correct path (the path of th6213-vcom.inf file provided by tonghui company), click "next", and select "always install this driver software" in the pop-up dialog box, Then the installation is completed (Figure 6-9).

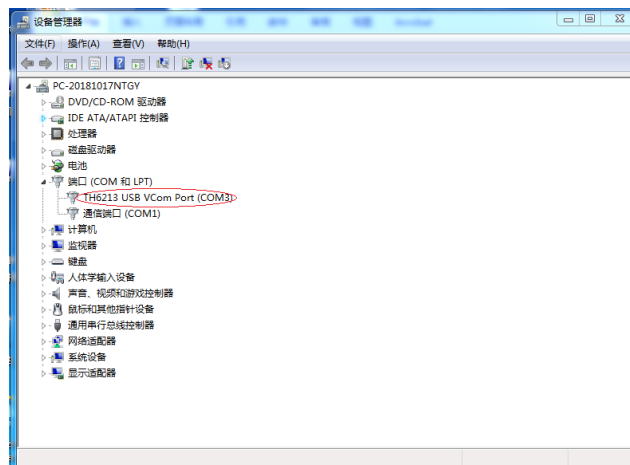

Figure 6-9

6.2 Command Instruction

Th6300 series power supply conforms to GPIB common command and SCPI (Standard Commands for Programmable Instrumentation) standard. The GPIB common command is defined by the IEEE 488.2-1987 standard and are applicable to all interfaces, but TH6300 series does not accept all the common command. SCPI command uses a hierarchical structure, and can have up to three hierarchies, where the highest level is called a subsystem command. The hierarchy under the subsystem command is valid only if the subsystem command is selected, using a colon to separate the hierarchy of the command.

6.2.1 Syntax Conventions

- (1) Cases are ignored

For example: FUNC:IMP CPD = func:imp cpd = Func:Imp CpD

- (2) A space is inserted to separate the command and the argument. The part before the space is the command, and the part after the space is the argument.

For example: FUNC: IMP CPD, IMP is the command and CPD is its argument.

- (3) Some command has no argument

For example: SYSTem:LOCK

- (4) Space cannot be inserted before or after a colon (“_” represents a space).

For example: FUNC_:_IMP CPD → FUNC:IMP CPD

- (5) Command can be abbreviated or spelled in full (abbreviations will be given in capital letters in subsequent instructions).

For example: FUNCTION:IMPEDANCE CPD = FUNC:IMP CPD

- (6) Command followed by a question mark (?) Execute a query corresponding to this command once.

For example: FUNC:IMP?

6.2.2 Command Reference

6.2.2.1 Supported GPIB Common Command

*RST: Used for reset the instrument

*TIG: Used for trigger output

*IDN?: Check the model information of the instrument

6.2.2.2 SCPI Command

Th6300 series power supply supports the following command, the command ignore cases, and the lower case letters can be omitted. Inside “<>” is the parameters, “<>” itself does not require input, “|” is used for separate parameters.

- System Command: SYSTem

- (1) SYSTem:LOCK

Set to remote control, the front panel buttons will be deactivated (except for LOCK/LOCAL buttons).

- (2) SYSTem:LOCAl

Set to local operation, the front panel buttons will be activated.

- (3) SYSTem:BEEPer

Test whether the buzzer works.

- (4) SYSTem:LOCK?

Inquire the current control state and return lock or local

(5) SYSTem:ADDRess?

Inquire the address of the instrument, and return an address value, such as '8'.

● Switch Page Command: DISPlay

(1) DISPlay:PAGE <OPD|SRD|TFD|FIL1~FIL10|TOPD|MEND>

This command is used for switching page display, the parameters inside "<>" has the following meaning:

OPD: OutPutDisp, Output Display page

SRD: SetRecallDisp, Recall List page

TFD: TrigFileDisp, Trig File page

FIL1~FIL10: File1~File10, File page

TOPD: TrigOutPutDisp, Trig File page

MEND: MenuDisp, Menu Set page

For example: disp:page opd, switch to output display page

(2) DISPlay?

Inquire the current page and return the value of the page abbreviation, such as "opd".

● Output Command: OUTPut

(1) OUTPut <0|1|ON|OFF>

This command is used for turning on/off the output

(2) OUTPut?

Inquire the current output state, return 0 or 1.

● Set Voltage Command: VOLTage

(1) VOLTage <Voltage|MIN|MAX|UP|DOWN|DEF >

This command is used for setting the voltage, the parameters within "<>" are explained below:

- Voltage: The required voltage value
- MIN: The minimum is 0
- MAX: The maximum depends on different models
- UP, DOWN: Add or subtract a value from the current voltage number, the value can be set by "VOLTage:STEP".
- DEF: Restore default, and the value is 1.

(2) VOLTage?

Inquire the current voltage value.

(3) VOLTage:STEP

This command is used to set stepping value, and used together with VOLTage <UP|DOWN>.

- (4) VOLTage:STEP?
Inquire the voltage stepping value.
 - (5) VOLTage:PROTection <Voltage|MIN|MAX>
This command is used for over voltage protection, minimum is 0, maximum depends on different models.
 - (6) VOLTage:PROTection?
Inquire the over voltage protection value.
 - (7) VOLTage:RANGe<HIGH|LOW|H|L>
This command is used for switching ranges, HIGH and H represent high voltage and low current range, LOW and L represent low voltage and high current range.
 - (8) VOLTage:RANGe?
Inquire the current range selected, return high or low.
- Set Current Command: CURRent
 - (1) CURRent <Current|MIN|MAX|UP|DOWN|DEF>
This command is used for setting the current, the parameters within “< >” are explained below:
 - Current: The required current value
 - MIN: The minimum is 0
 - MAX: The maximum depends on different models
 - UP, DOWN: Add or subtract a value from the current number, the value can be set by “CURRent:STEP”.
 - DEF: Restore default, and the value is 1.
 - (2) CURRent?
Inquire the current value.
 - (3) CURRent:STEP <Value>
This command is used to set stepping value, and used together with CURRent <UP|DOWN>.
 - (4) CURRent: STEP?
Inquire the current stepping value.
 - (5) CURRent:PROTection<Current|MIN|MAX>
This command is used for over current protection, minimum is 0, maximum depends on different models.
 - (6) CURRent:PROTection?
Inquire the over current protection value.

- Set Timer Command: TIMer
 - (1) TIMer <0|1|ON|OFF>

This command is used to set the timer to on or off.
 - (2) TIMer?

Inquire the timer is on or off, and return 0 or 1.
 - (3) TIMer:DATA <0~99999.9>

This command is used to set the timer, minimum is 0, and maximum is 99999.9s.
 - (4) TIMer:DATA?

Inquire the current setting value of the timer.

- APPLy
 - (1) APPLy <Voltage>, <Current>

Set voltage and current at the same time.
 - (2) APPLy?

Inquire the voltage setting value and current setting value.

- TRIGger
 - (1) TRIGger:SOURce <MANual|BUS>

This command is used to set the trigger mode, MANual means trigger manually, BUS means trigger by BUS signal.
 - (2) TRIGger:SOURce?

Inquire the trigger mode, and return manual or bus.
 - (3) TRIGger <1~10>,<0|1|ON|OFF>

This command is used to trigger file or stop triggering files, the numbers within the first "< >" represents the selected file index, the parameters within the second "< >" means triggering files or stopping triggering files.
 - (4) TRIGger?

Inquire the index of the current triggering file. If there's no triggering file, return 0.

- Measuring Command: MEASure
 - (1) MEASure: VOLTage?

Inquire the current measured voltage value.
 - (2) MEASure: CURRent?

Inquire the current measured current value.
 - (3) MEASure: POWer?

Inquire the current measured power value.

(4) MEASure: TIMer?

Inquire the current timer value.

● Edit File Command: tLIST

This command is used to edit trigger file.

(1) tLIST:EDIT <1~10>

This command is used to select the file that need to be edited. This is a necessary step before editing the trigger file.

(2) tLIST:EDIT?

Inquire the selected file.

(3) tLIST:VOLTage <1~100>,<voltage>

This command is used to set the voltage in the selected file, within the first "< >" is the file index, within the second "< >" is the desired voltage value.

(4) tLIST:VOLTage?<1~100>

Inquire the voltage value of the selected file, the numbers within "< >" represents the file index that need to be inquired.

(5) tLIST:CURREnt <1~100>,<Current>

This command is used to set the current in the selected file, within the first "< >" is the file index, within the second "< >" is the desired current value.

(6) tLIST:CURREnt?<1~100>

Inquire the current value of the selected file, the numbers within "< >" represents the file index that need to be inquired.

(7) tLIST:TIME <1~100>,<Time>

This command is used to set the time value of the selected file, the numbers within the first "< >" represents the file index, the numbers within the second "< >" represents the required time value.

(8) tLIST:TIME?<1~100>

Inquire the time value of the selected file, numbers within "< >" represents the file index.

(9) tLIST:EMPTY <1~10>

This command is used to clear all the data of the selected file.

(10) tLIST:STArt <1~100>

This command is used to set the data index that will be triggered firstly.

(11) tLIST:STArt?

Inquire the data index that will be triggered firstly.

(12) tLIST:END <1~100>

This command is used to set the data index that will be triggered in the end.

(13) tLIST:END?

Inquire the data index that will be triggered in the end.

(14) tLIST:REPet <1~65536>

This command is used to set the number of cycles of the trigger file, the maximum is 65535 times.

(15) tLIST:REPet?

Inquire the number of cycles of the trigger file.

● Recall Command: FUNCtion

(1) FUNCtion:SAVe

This command is used to save voltage setting value, current setting value, and some other setting values in the recall list.

(2) FUNCtion:RECall <1~100>

This command is used to recall a set of data from recall list.

(3) FUNCtion:RECall?<1~100>

Inquire a set of voltage setting value and current setting value from recall list.

(4) FUNCtion:DELeTe <1~100|ALL>

This command is used to clear a set of data or delete the entire data table from the recall list.

● Menu Function Command: MENu

(1) MENu:DVM <0|1|OFF|ON>

This command is used to turn on/off voltage measurement function.

(2) MENu:DVM?

Inquire the DVM function is turned on or off.

(3) MENu:LANG <0|1|EN|CN>

This command is used to select the language, 0 and CN represent Chinese, 1 and EN represent English.

(4) MENu:LANG?

Inquire the current selected language, return cn or en.

(5) MENu:VOICe <0|1|ON|OFF>

This command is used to turn on/off buzzer.

(6) MEnu:VOICe?

Inquire the buzzer is on or off.

(7) MEnu:PMEM <0|1|RESet|LOAD>

This command is used to set power on memory status, 0 and RESet means restore to default, 1 and LOAD means restore the saved data.

(8) MEnu:PMEM?

Inquire the state of electric.

(9) MEnu:TrigMODE <0|1|MANual|BUS>

This command is used to set trig mode, the function is same as TRIGger:SOURce <MANual|BUS>.

(10)MEnu:TrigMODE?

Inquire the current trig mode, the function is same as TRIGger:SOURce?.

(11) MEnu:SAMP <TWO|FOUR>

This command is used to set sampling mode, TWO represents two ports sampling, FOUR represents four ports sampling.

(12) MEnu:SAMP?

Inquire the current sampling mode, and return two or four.

● Date Clock Command: DATE

(1) DATE:<YEAR|MONth|DATE|HOUR|MIN|SEC> <setting value>

This command is used to set RTC clock, the parameters in the first “<>” are year, month, date, hour, minute, second, and in the second “<>” is the required value

(2) DATE?

Inquire the current date.

Chapter 7 Specification

| Parameter | | TH6201 | TH6202 | TH6203 |
|-----------------------------|--------------------------------|--|--|--|
| Rated Output | Two Ranges | 20V,5A/8V,10A | 32V,3A/15V,6A | 72V,1.5A/32V,3A |
| Load Regulation | Voltage | $\leq 0.01\%+4\text{mV}$ | $\leq 0.01\%+3\text{mV}$ | $\leq 0.01\%+3\text{mV}$ |
| | Current | $\leq 0.01\%+2\text{mA}$ | $\leq 0.01\%+2\text{mA}$ | $\leq 0.01\%+2\text{mA}$ |
| Power Supply Regulation | Voltage | $\leq 0.01\%+4\text{mV}$ | $\leq 0.01\%+3\text{mV}$ | $\leq 0.01\%+3\text{mV}$ |
| | Current | $\leq 0.01\%+2\text{mA}$ | $\leq 0.01\%+2\text{mA}$ | $\leq 0.01\%+2\text{mA}$ |
| Resolution of Setting Value | Voltage | 1mV | 1mV | 1mV |
| | Current | 0.1mA | 0.1mA | 0.1mA |
| Resolution of Reread Value | Voltage | 1mV | 1mV | 1mV |
| | Current | 0.1mA | 0.1mA | 0.1mA |
| Accuracy of Setting Value | Voltage | $\leq 0.04\%+8\text{mV}$ | $\leq 0.04\%+8\text{mV}$ | $\leq 0.04\%+8\text{mV}$ |
| | Current | $\leq 0.1\%+5\text{mA}$ | $\leq 0.1\%+5\text{mA}$ | $\leq 0.1\%+5\text{mA}$ |
| Accuracy of Reread Value | Voltage | $\leq 0.04\%+8\text{mV}$ | $\leq 0.04\%+8\text{mV}$ | $\leq 0.04\%+8\text{mV}$ |
| | Current | $\leq 0.1\%+5\text{mA}$ | $\leq 0.1\%+5\text{mA}$ | $\leq 0.1\%+5\text{mA}$ |
| Ripple and Noise | Differential Mode Voltage | $\leq 3\text{mVp-p}$ and 1mVrms | $\leq 3.5\text{mVp-p}$ and 1mVrms | $\leq 3.5\text{mVp-p}$ and 1mVrms |
| | Differential Mode Current | $< 9\text{mA}_{\text{rms}}$ | $< 7\text{mA}_{\text{rms}}$ | $< 6\text{mA}_{\text{rms}}$ |
| | Common Mode Current | $< 1.5\mu\text{A}_{\text{rms}}$ | $< 1.5\mu\text{A}_{\text{rms}}$ | $< 1.5\mu\text{A}_{\text{rms}}$ |
| Dynamic Recovery Time | Restore to 75mV (50%~100%load) | $< 50\mu\text{s}$ | $< 50\mu\text{s}$ | $< 50\mu\text{s}$ |
| Rise Time | 10%-90% | $< 90\text{ms}$ | $< 90\text{ms}$ | $< 90\text{ms}$ |
| Fall Time | 90%-10% | $< 150\text{ms}$ | $< 200\text{ms}$ | $< 250\text{ms}$ |